HP Notebook PC

———— Reference Guide

Thank you for purchasing this Factory Service Manual CD/DVD from servicemanuals4u.com.

Please check out our eBay auctions for more great deals on Factory Service Manuals:

servicemanuals4u

Notice

This manual and any examples contained herein are provided “as is” and are subject to change without notice. Hewlett-Packard Company makes no warranty of any kind with regard to this manual, including, but not limited to, the implied warranties of merchantability and fitness for a particular purpose. Hewlett-Packard Co. shall not be liable for any errors or for incidental or consequential damages in connection with the furnishing, performance, or use of this manual or the examples herein.

Consumer transactions in Australia and the United Kingdom: The above disclaimers and limitations shall not apply to Consumer transactions in Australia and the United Kingdom and shall not affect the statutory rights of Consumers.

© Copyright Hewlett-Packard Company 2002. All rights reserved. Reproduction, adaptation, or translation of this manual is prohibited without prior written permission of Hewlett-Packard Company, except as allowed under the copyright laws.

The programs that control this product are copyrighted and all rights are reserved. Reproduction, adaptation, or translation of those programs without prior written permission of Hewlett-Packard Co. is also prohibited.

Portions of the programs that control this product may also be copyrighted by Microsoft Corporation, Phoenix Technologies, Ltd., ATI Technologies Inc., Intel Corporation, and Adobe Systems Incorporated. See the individual programs for additional copyright notices.

This product incorporates copyright protection technology that is protected by method claims of certain U.S. patents and other intellectual property rights owned by Macrovision Corporation and other rights owners. Use of this copyright protection technology must be authorized by Macrovision Corporation and is intended for home and other limited viewing uses only unless otherwise authorized by Macrovision Corporation. Reverse engineering or disassembly is prohibited.

Microsoft®, MS-DOS®, and Windows® are U.S. registered trademarks of Microsoft Corporation. Pentium® and the Intel Inside logo are U.S. registered trademarks and Celeron™ and SpeedStep™ are U.S. trademarks of Intel Corporation. Adobe® and Acrobat® are trademarks of Adobe Systems Incorporated.

Hewlett-Packard Company
HP Notebook Customer Care
1000 NE Circle Blvd., MS 425E
Corvallis, OR 97330

Important Safety Information

CAUTION

To reduce the risk of fire, use only No. 26 AWG or larger telecommunications line cord to connect a modem to the telephone wall jack. In Australia, the computer must be connected to the Telecommunication Network through a line cord that meets the requirements of ACA Technical Standard TS008.

When using your computer with a telephone connection, always follow basic safety precautions to reduce the risk of fire, electric shock, and injury to persons:

- Do not use this product with a telephone connection near water (for example, near a bathtub, sink, swimming pool, or in a wet basement).
- Avoid using a telephone connection (other than a cordless type) during an electrical storm. There may be a remote risk of electric shock from lightning.
- Do not use a telephone connection to report a gas leak in the vicinity of the leak.
- Use only the power cord and batteries indicated in this manual. Do not dispose of batteries in a fire. They may explode. Check with local codes for possible special disposal instructions.

HP Software Product License Agreement

Your HP product contains software programs. CAREFULLY READ THIS LICENSE AGREEMENT BEFORE PROCEEDING TO OPERATE THIS EQUIPMENT. RIGHTS IN THE SOFTWARE ARE OFFERED ONLY ON THE CONDITION THAT THE CUSTOMER AGREES TO ALL TERMS AND CONDITIONS OF THE LICENSE AGREEMENT. PROCEEDING TO OPERATE THE EQUIPMENT INDICATES YOUR ACCEPTANCE OF THESE TERMS AND CONDITIONS. IF YOU DO NOT AGREE WITH THE TERMS OF THE LICENSE AGREEMENT, YOU MUST NOW EITHER REMOVE THE SOFTWARE FROM YOUR HARD DISK DRIVE AND DESTROY THE MASTER DISKETTES, OR RETURN THE COMPLETE HP PRODUCT AND SOFTWARE FOR A FULL REFUND. PROCEEDING WITH CONFIGURATION SIGNIFIES YOUR ACCEPTANCE OF THE LICENSE TERMS.

UNLESS OTHERWISE STATED BELOW, THIS HP SOFTWARE LICENSE AGREEMENT SHALL GOVERN THE USE OF ALL SOFTWARE THAT IS PROVIDED TO YOU AS PART OF THE HP PRODUCT AND SHALL SUPERSEDE ANY OTHER SOFTWARE WARRANTY STATEMENT THAT MAY BE INCLUDED IN THIS HP PRODUCT OR MAY BE FOUND ONLINE.

Operating system and software applications by Microsoft are licensed to you under the Microsoft License Agreement contained in the Microsoft documentation or displayed on your screen when Microsoft Software Products are launched.

For a PC supplied with a Microsoft operating system: When you start the PC and accept the Microsoft End-user License Agreement (“EULA”), your license rights are valid only if a Certificate of Authenticity (“COA”) label corresponding to your Microsoft operating system is provided with your PC. The COA label can usually be found on the bottom of the computer. If the COA label does not correspond to your Microsoft operating system or is missing, contact your HP reseller for details.

Other non-HP Software and Operating Systems are covered by the appropriate vendor license. The following License Terms govern the use of the HP software:

USE. Customer may use the software on any one HP product. Customer may not network the software or otherwise use it on more than one HP product. Customer may not reverse assemble or decompile the software unless authorized by law.

COPIES AND ADAPTATIONS. Customer may make copies or adaptations of the software a) for archival purposes or (b) when copying or adaptation is an essential step in the use of the software with an HP product so long as the copies and adaptations are used in no other manner.

OWNERSHIP. Customer agrees that he/she does not have any title or ownership of the software, other than ownership of the physical media. Customer acknowledges and agrees that the software is copyrighted and protected under the copyright laws. Customer acknowledges and agrees that the software may have been developed by a third party software supplier named in the copyright notices included with the software, who shall be authorized to hold the Customer responsible for any copyright infringement or violation of this Agreement.

PRODUCT RECOVERY CD-ROM or DVD. If your HP product was shipped with a product recovery CD-ROM or DVD: (i) The product recovery CD-ROM or DVD and/or support utility software may only be used for restoring the hard disk of the HP product with which the product recovery CD-ROM or DVD was originally provided. (ii) The use of any operating system software by Microsoft contained in any such product recovery CD-ROM or DVD shall be governed by the Microsoft License Agreement.

TRANSFER OF RIGHTS IN SOFTWARE. Customer may transfer rights in the software to a third party only as part of the transfer of all rights and only if Customer obtains the prior agreement of the third party to be bound by the terms of this License Agreement. Upon such a transfer, Customer agrees that his/her rights in the software are terminated and that he/she will either destroy his/her copies and adaptations or deliver them to the third party.

SUBLICENSING AND DISTRIBUTION. Customer may not lease, sublicense the software or distribute copies or adaptations of the software to the public in physical media or by telecommunication without the prior written consent of Hewlett-Packard.

TERMINATION. Hewlett-Packard may terminate this software license for failure to comply with any of these terms provided Hewlett-Packard has requested Customer to cure the failure and Customer has failed to do so within thirty (30) days of such notice.

UPDATES AND UPGRADES. Customer agrees that the software does not include updates and upgrades which may be available from Hewlett-Packard under a separate support agreement.

EXPORT CLAUSE. Customer agrees not to export or re-export the software or any copy or adaptation in violation of the U.S. Export Administration regulations or other applicable regulation.

U.S. GOVERNMENT RESTRICTED RIGHTS. Use, duplication, or disclosure is subject to HP standard commercial license terms and for non-DOD Departments and Agencies of the U.S. Government, the restrictions set forth in FAR 52.227-19(c)(1-2) (June 1987) Hewlett-Packard Company, 3000 Hanover Street, Palo Alto, CA 94304 U.S.A. Copyright (c) 2000 Hewlett-Packard Company. All Rights Reserved. Customer further agrees that Software is delivered and licensed as “Commercial computer software” as defined in DFARS 252-227-7014 (June 1995) or as a “commercial item” as defined in FAR 2.101(a), or as “Restricted computer software” as defined in FAR 52.227-19 (or any equivalent agency regulation or contract clause), whichever is applicable. The Customer agrees that it has only those rights provided for such Software by the applicable FAR or DFARS clause or the HP standard software agreement for the product involved.

Support Policy for Microsoft Operating Systems Service Pack. HP will provide end user support for HP PCs that use Microsoft Operating Systems, including its latest service packs. This support will be available 30 days after the service pack being released by Microsoft.

Edition History

Edition 1 (KA, KB) July 2002



This manual is printed on recycled paper.

Contents

Getting Started with Your HP Notebook	11
Taking Inventory.....	12
What's in the box?	12
To buy accessories	12
To find more information.....	13
Identifying Parts of the Computer.....	14
Front View	14
Back View	15
Bottom View	16
Status Lights.....	17
Setting Up Your Computer	19
Step 1: Install the battery	19
Step 2: Connect AC power.....	21
Step 3: Connect a phone line.....	22
Step 4: Turn on the computer.....	23
Step 5: Set up Windows	23
Step 6: Register your notebook.....	24
To connect to the Internet	24
What to do next.....	24
Basic Operation	25
Operating Your Computer	26
To turn the computer on and off	26
To reset the computer.....	27
To change the boot device.....	27
To use the touch pad	28
To use the Fn hot keys	30
To use the One-Touch buttons	31
To use the Windows and Applications keys	32
To use the embedded keypad	33
To use the ALT GR key	33
To adjust the display	34
To adjust the volume.....	35
To change computer settings for a presentation.....	35
Using CDs or DVDs	37
To insert or remove a CD or DVD.....	37
To play DVD movies	38
To create or copy CDs	38
Securing Your Computer	39
To set up password protection.....	39
To lock your computer	39
To attach a security cable.....	40

To protect against viruses	41
To lock the hard disk drive.....	41
Working in Comfort with a Notebook PC	42
Taking Care of Your Computer	44
To protect your hard disk drive.....	44
To maintain your computer.....	44
To safeguard your data.....	45
To extend the life of the display.....	45
To clean your computer	46
Batteries and Power Management	47
Managing Power Consumption	48
How the computer manages power automatically	48
To manage power manually.....	50
Using Battery Power.....	51
To check battery status.....	51
To respond to a low-battery warning	52
To recharge the battery	52
To get the most from your batteries	52
Modem and Network Connections.....	55
Using the Modem.....	56
To connect the modem	57
To connect to the Internet	58
To disconnect from the Internet	59
To dial in to a network	59
To change your modem settings	60
To send and receive e-mail	61
To send and receive faxes	62
Connecting to a LAN.....	63
To connect to a LAN.....	63
Making Wireless Network Connections	64
To prepare for connections.....	64
To turn wireless communication on and off.....	66
Making Wireless Bluetooth Connections	68
To turn Bluetooth communication on and off.....	68
To prepare for Bluetooth connections.....	70
To send or receive files using Bluetooth.....	71
To connect to a Bluetooth printer or serial device	72
To make a dial-up connection via a Bluetooth phone	73
Add-On Devices	75
Connecting PC Cards.....	76
To insert or remove a PC Card.....	76

Connecting External Devices.....	78
To identify connectors for external devices	78
To connect a printer or other parallel device.....	80
To connect an external keyboard or mouse.....	80
To connect a USB device.....	80
To connect an audio device.....	81
To use an external monitor.....	82
To use a TV set as a monitor.....	83
To connect an IEEE 1394 device	85
To connect a serial device	85
To connect an infrared device	85
To use a port replicator	87
Installing Additional RAM	89
To install a RAM expansion module	89
To remove a RAM expansion module	90
Replacing the Hard Disk Drive.....	91
To replace the hard disk drive.....	91
To replace the hard disk drive holder.....	92
To prepare a new hard disk drive.....	93
Troubleshooting and Maintenance	95
Troubleshooting Your Computer.....	96
Audio Problems.....	96
CD-ROM and DVD Problems	97
Display Problems	99
Hard Disk Drive Problems	100
Heat Problems	101
Infrared Problems.....	101
Keyboard and Pointing Device Problems	102
LAN Problems	103
Memory Problems.....	104
Modem Problems	104
PC Card (PCMCIA) Problems	107
Performance Problems	108
Port Replicator Problems	109
Power and Battery Problems.....	109
Printing Problems.....	111
Serial, Parallel, and USB Problems.....	112
Startup Problems	113
Wireless Problems.....	114
Testing the Hardware.....	116
To run the e-Diagtools diagnostic test	116
Configuring the Computer	118
To run the BIOS Setup utility	118
Reinstalling and Updating Software	122
To recover the factory installation of your hard disk	122
To replace a damaged Recovery CD or DVD.....	123

To update the BIOS.....	123
To update Windows drivers	124
HP Support and Service.....	125
Getting Assistance for Your Computer.....	126
To get help from the Web	126
To contact HP for support or service	126
To receive repair service	128
To prepare your computer for shipment.....	129
Hewlett-Packard Limited Warranty Statement.....	130
Reference Information	133
Hardware Specifications	134
Modem Reference Information.....	138
Modem Reference (Conexant)	138
Safety Information	145
Power Cords.....	145
Ergonomics	146
Battery Safety.....	146
Laser Safety.....	147
LED Safety.....	147
Mercury Safety.....	148
Exposure to Radio Frequency Radiation.....	148
Regulatory Information.....	149
U.S.A.....	149
Canada.....	150
European Union	151
Japan	153
Russia	154
International	154
Index	157

Getting Started with Your HP Notebook

Taking Inventory

Congratulations! Your notebook computer sets a new standard in personal computing. Although compact and easy to carry, your computer is made with the quality and attention to detail that are the hallmark of Hewlett-Packard.

This manual shows how to set up and operate your computer, as well as what to do if you run into trouble.

What's in the box?

- HP notebook PC.
- Battery (installed).
- AC adapter and power cord.
- Quick Start sheet.
- *Startup Guide*.
- *Recovery CD* or *DVD*, for restoring Windows and all software included with your computer.
- Microsoft Windows manual.
- CD with special software (for models with certain types of drives).

In addition, your HP notebook includes preinstalled software. (The exact software installed depends on your particular notebook model.)

To buy accessories

You can buy accessories for your computer online. For the latest accessories and options, visit the HP Notebook Web site (www.hp.com/notebooks).

HP currently offers accessories, such as the following:

- AC adapter.
- Replacement hard disk drive module.

- RAM modules for expanding memory.
- Battery.
- Port replicator.

To find more information

The following table lists other sources of information about your computer and related products.

Source	Description and Location
<i>Startup Guide</i>	This printed manual introduces your computer. It also contains setup instructions, basic operation guidelines, troubleshooting information, and warranty information.
<i>Online Reference Guide</i>	The full <i>Reference Guide</i> is shipped on the computer's hard drive, and provides a complete source for operating and maintaining the computer. Look in the online HP Library, or on the <i>Recovery CD</i> or <i>DVD</i> in \hp\Library. The HP Library is in the Help and Support Center.
Online HP Notes	For late-breaking information available after the manuals were completed, see the HP Notes in the online HP Library, or on the <i>Recovery CD</i> or <i>DVD</i> in \hp\Library.
Microsoft Windows manual	This is shipped with your computer and contains information about using the version of Microsoft Windows shipped with your computer.
HP Notebook Web Site	www.hp.com/notebooks www.europe.hp.com/notebooks (European mirror). To select another language, see www.hp.com .
HP Business Support Web Site	www.hp.com/go/bizsupport

Identifying Parts of the Computer

Front View

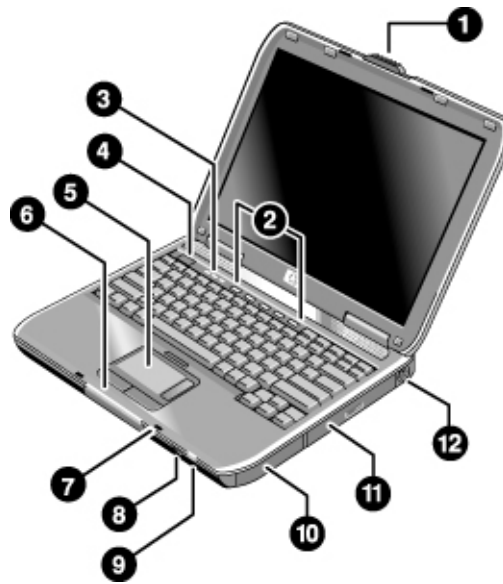

- | | |
|---|--|
| 1. Computer open/close latch. | 7. Built-in microphone*. |
| 2. One-Touch buttons. | 8. Infrared port*. |
| 3. Keyboard status lights. | 9. Wireless on-off button and indicator light*. |
| 4. Power button. Turns the computer on and off. | 10. Battery. |
| 5. Touch pad, scroll pad, click buttons, plus on-off button. | 11. CD-ROM, DVD, or other drive. |
| 6. Main status lights (left to right): power mode, battery, hard disk activity. | 12. PS/2 keyboard or PS/2 mouse port (supports Y adapter). |

* on certain models

Back View

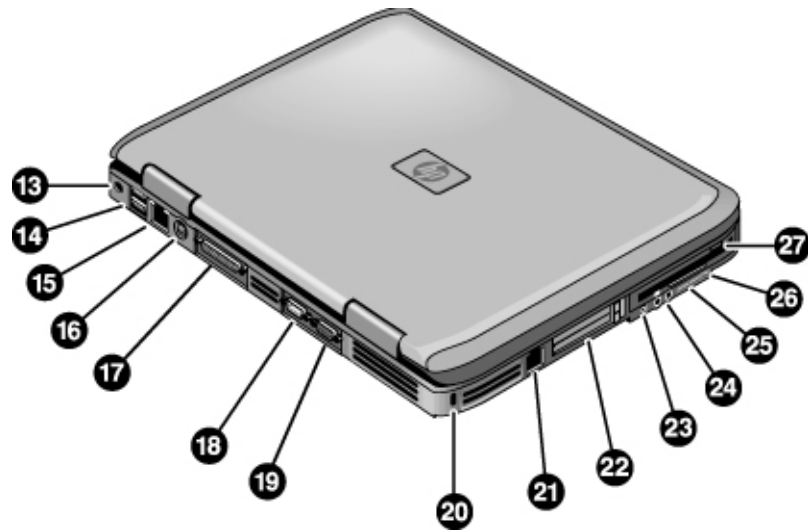

- | | |
|---|--|
| 13. AC adapter jack. | 21. Modem port*. |
| 14. Two universal serial bus ports (USB). | 22. PC Card and CardBus slot and button (certain models have two slots and two buttons). |
| 15. LAN port*. | 23. IEEE 1394 port*. |
| 16. S-video port*. | 24. Audio jacks (left to right): external microphone, audio out (headphones). |
| 17. Parallel port (LPT1). Use this port for a parallel printer or other parallel device. | 25. Volume control*. |
| 18. Serial port (COM1). Use this port for a serial mouse, modem, printer, or other serial device. | 26. Audio mute button and audio mute light*. |
| 19. External monitor port. | 27. Floppy disk drive*. |
| 20. Kensington lock slot (security connector). | * on certain models |

Getting Started with Your HP Notebook
Identifying Parts of the Computer

Bottom View

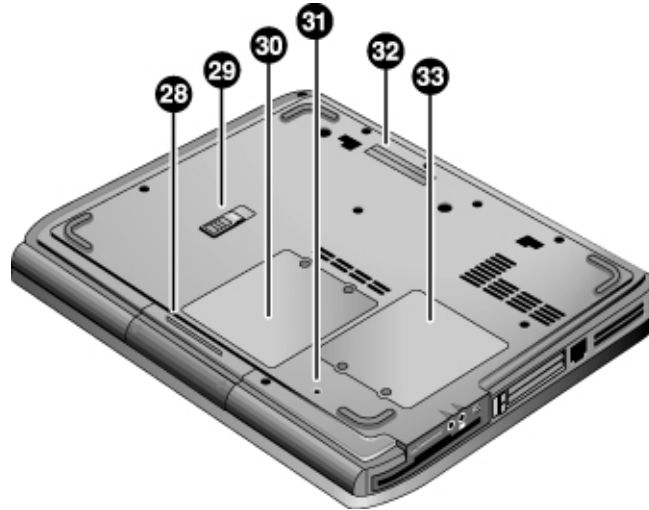

- 28. Hard disk drive.
- 29. Battery latch.
- 30. RAM cover.

- 31. Reset button.
 - 32. Docking port*.
 - 33. Mini-PCI cover (no user parts inside).
- * on certain models

Status Lights

The computer includes a number of status lights that report power and battery status, drive activity, and keyboard functions such as Caps Lock and Num Lock.

The following diagram shows the main status lights on the front of the computer.

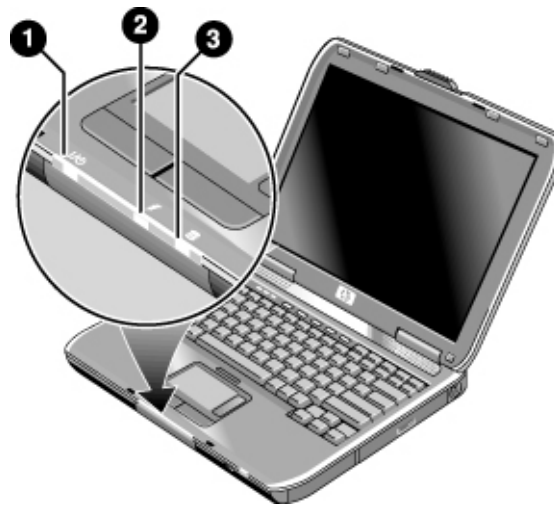

1. Power mode.

- On: the computer is on (even if the display is off).
- Blinking: the computer is in Standby mode.
- Off: the computer is off or in Hibernate mode.

2. Hard disk drive activity.

- On: computer is accessing the hard disk drive.

3. Battery status.

- Green: the AC adapter is connected and the battery is fully charged.
- Amber: the AC adapter is connected and the battery is charging.
- Blinking: the AC adapter is connected and the battery is missing or has a fault.
- Off: the AC adapter is not connected.

Getting Started with Your HP Notebook Identifying Parts of the Computer

The keyboard status lights, located above the keyboard, indicate the states of the keyboard locks.

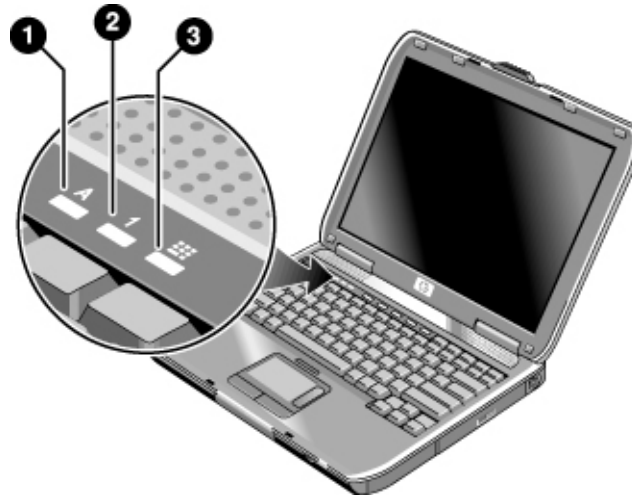

1. **Caps Lock.** Caps Lock is active.
2. **Num Lock.** Num Lock is active. (The Keypad Lock must also be on to use the embedded keypad.)
3. **Keypad Lock.** The embedded keypad is active (Fn+F8). Num Lock must also be on for the numeric keys—otherwise, cursor control is active (as marked on an external keyboard).

Setting Up Your Computer

WARNING

Improper use of keyboards and other input devices has been associated with ergonomic injury. For information about reducing your risk, see *Working in Comfort* in the online HP Library, or visit our ergonomics Web site, www.hp.com/ergo. For a summary about working with a notebook computer, see “*Working in Comfort with a Notebook PC*” on page 42.

If you are using your notebook computer as your primary computer, or using it for extended periods, you should use it with a full-size keyboard, monitor, and mouse. HP docking accessories offer quick, easy connections to these devices. This can reduce the risk of ergonomic injury. See *Working in Comfort* in the online HP Library.

When you set up your computer for the first time, you'll install and charge the battery, connect the AC adapter, turn on the computer, and run the Windows setup program.

Step 1: Install the battery

WARNING

Do not mutilate or puncture batteries. Do not dispose of batteries in fire, or they can burst or explode, releasing hazardous chemicals. Rechargeable batteries must be recycled or disposed of properly.

Your computer is shipped with the battery installed. If the battery has been removed, you should install it:

1. Turn the computer upside down.
2. Insert the connector end of the battery into the battery compartment and slide it in until it latches.

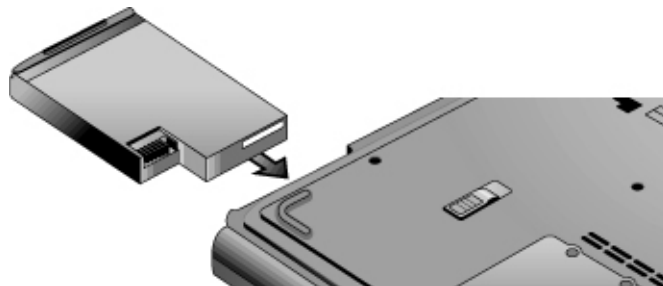

Getting Started with Your HP Notebook
Setting Up Your Computer

To remove the battery

1. Before removing the battery, do one of the following:
 - Shut down the computer or put it into Hibernate mode, or
 - Plug in the AC adapter.
2. Slide the battery's release latch, and then slide the battery out of its compartment.

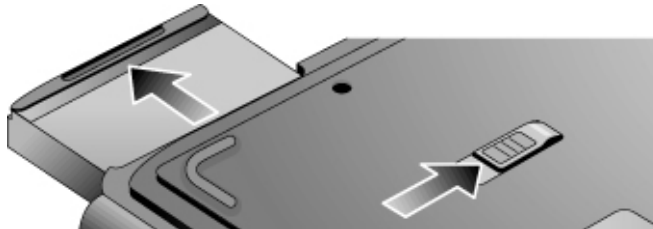

Step 2: Connect AC power

CAUTION

Use only the HP AC adapter included with your computer (or other approved adapter that meets the power requirements of the computer).

If “75W” is printed below the AC adapter socket on the computer, do not use a 60-watt, 3.16-amp adapter, such as HP F1454A or F1781A, and do not use DC adapter accessories F1455A and F2297A.

Using the wrong AC adapter could damage the computer or adapter and may void your warranty (see "Hewlett-Packard Limited Warranty Statement" on page 130).

- Plug the AC adapter into the computer and connect the power cord to the AC adapter, then plug the power cord into a wall outlet. The computer's battery then starts charging.

Important

When unplugging the power cord, unplug it from the outlet before unplugging it from the AC adapter.

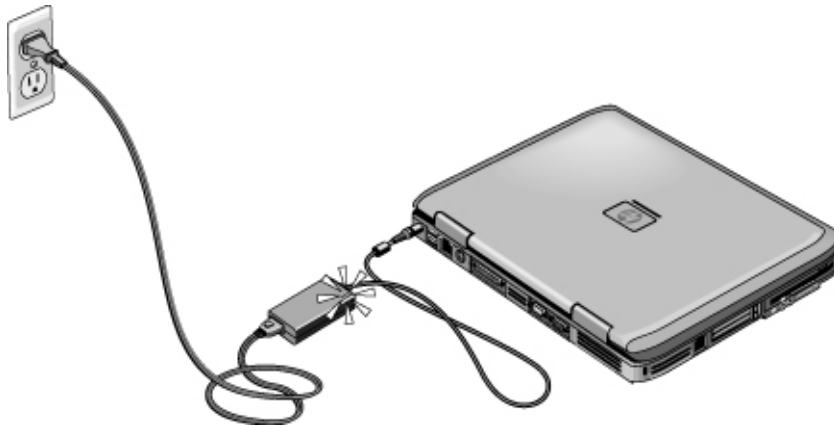

While the battery is charging, you can continue with step 3.

Step 3: Connect a phone line

If your computer does not include a built-in modem, you can skip this step. Also, if you prefer, you can instead connect to a PC Card modem or an external modem.

1. Make sure the telephone line is an analog line, sometimes called a data line. (You must not use a digital line.)
2. Connect the telephone cord into a telephone jack. If the plug on the phone cord doesn't fit the jack, you may need to use an adapter.
3. Plug the other end of the phone cord into the built-in modem.



For details about using the modem, see “Using the Modem” on page 56.

Step 4: Turn on the computer

- Press the power button above the left side of the keyboard. The computer then boots up, and Windows starts automatically.



Hint

If your computer does not turn on when operating on battery power, the battery may be out of power. Plug in the AC adapter and press the power button again. Leave the AC adapter plugged in for at least an hour—or 2–3 hours to charge it fully.

Step 5: Set up Windows

Your notebook computer has Microsoft Windows preinstalled on its hard disk drive. The first time you turn on your computer, the Windows Setup program runs automatically so you can customize your setup.

1. Follow the Setup program's instructions as they appear on the screen. If the program prompts you to enter the Product ID code, you will find this code on the bottom of the computer.
2. If your computer has a modem, check the modem's country or region settings: click Start, Control Panel, Printers and Other Hardware, Phone and Modem Options, and then click Edit on the Dialing Rules tab.

Step 6: Register your notebook

Be sure to register your computer. Registering is free and fast, and ensures you will receive quicker, more personalized support. The information you provide during registration allows us to provide you with better products and services.

Registering your computer does the following:

- Records your ownership of the computer with Hewlett-Packard and provides access to service, support, and information.
- Records your ownership of the Windows XP operating system with Microsoft.

If you decide not to register during Windows setup, choose the option to print the registration form, and then fax it to HP at the fax number on the form. Or you can register by calling HP Customer Care—see “To contact HP for support or service” on page 126 to find the phone number.

To connect to the Internet

If you are connected to a wired or wireless LAN with Internet access or your computer has a modem (built-in, PC Card, or external), you can connect to the Internet. For details, see “Using the Modem” on page 56, “Connecting to a LAN” on page 63, or “Making Wireless Network Connections” on page 64.

What to do next

- If you’re not familiar with Windows XP, click Start, Tour Windows XP, or check the Windows manual to discover what’s new.
- See the online *Reference Guide* to learn more about using and maintaining your computer—click Start, Help and Support, HP Library.

Basic Operation

Operating Your Computer

You can start and stop your computer using its power button. However, at certain times you may want to use other methods to start or stop the computer—depending on power considerations, types of active connections, and start-up time.

To turn the computer on and off

Power mode	To enter this mode
On mode Power mode status light is on.	Press the power button.
Standby mode Saves significant power. Turns off the display and other components. Maintains current session in RAM. Restarts quickly. Restores network connections. Power mode status light is blinking.	Press the power button –or– click Start, Turn Off Computer, Stand By –or– allow timeout.
Hibernate mode Saves maximum power. Saves current session to disk, then shuts down. Restores network connections. Power mode status light is off.	Press Fn+F12 –or– allow timeout.
Shut down (off) Saves maximum power. Turns off without saving current session. At startup, resets everything, starts a new session, and restores network connections. Power mode status light is off.	Click Start, Turn Off Computer, Turn Off –or– press the power button for 4 seconds (only if the Start menu procedure doesn't work).
To turn on: Press the power button to restart, or to resume your session from Standby or Hibernate mode.	

You can also customize the way these power modes work. See “How the computer manages power automatically” on page 48.

To reset the computer

Occasionally, you may find that Windows or the computer has stopped responding, and will not let you turn the computer off. If this happens, try the following in the order listed.

- If possible, shut down Windows: press CTRL+ALT+DEL, and then click Shut Down, Restart.
–or, if this fails–
- Press the power button for 4 seconds until the display shuts down, and then press the power button again to restart.
–or, if this fails–
- Insert the tip of a ballpoint pen into the reset button on the bottom of the computer, and then press the power button to restart.

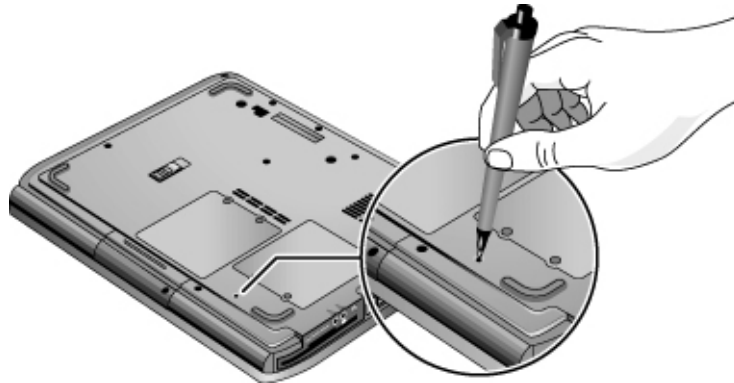

To reset the computer while it's docked in a port replicator, you can press the reset button on the left side of the port replicator.

To change the boot device

The computer normally boots from its internal hard disk. You can also boot the computer from a floppy disk drive, a CD-ROM drive, or an internal network interface card.

1. Click Start, Turn Off Computer, Restart.
2. When the HP logo appears, press ESC to display the Boot menu.

Basic Operation

Operating Your Computer

3. Use the arrow keys to select the boot device, and press ENTER.

If you want to boot from a specific device whenever it is present, change the boot order using the BIOS Setup utility—see “To run the BIOS Setup utility” on page 118.

To use the touch pad

The touch pad includes an on-off button so you can turn off the touch pad to avoid moving the pointer accidentally, such as by touching the pad while typing. The indicator light turns off when you turn off the touch pad.

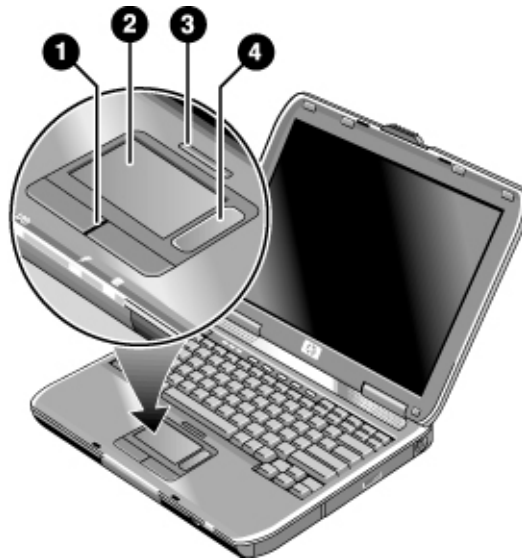

1. Click buttons. The click buttons work like the left and right buttons on a standard mouse.
2. Touch pad (touch-sensitive pointing device).
3. Touch pad on-off button and indicator light.
4. Scroll pad. The scroll pad scrolls the contents of the active window.

Moving and selecting

1. Place your hands in a normal typing position.
2. Move a thumb or finger across the touch pad in the direction you want the pointer to move.
3. Use the left and right click buttons, which function like the left and right buttons on a mouse, to make your selection:
 - To open an application, move the pointer over the icon and double-click the left button.
 - To make menu selections, move the pointer to the menu item and click the left button.
 - To open the shortcut menu for an item, move the pointer over the item and click the right button.
 - To drag an item, move the pointer over the item. Then press *and hold* the left button while you move the pointer to the new location, and release the button.

In addition, you can tap the touch pad to select items and use other advanced touch pad features. For more information, double-click the touch pad icon in the taskbar, and then click Help in the tab for a particular feature.

You can use Mouse in Control Panel or the touch pad icon in the taskbar to customize the operation of your computer's pointing devices (touch pad and external mouse): you can change the left, right, and scroll pad actions, double-click speed, pointer speed, and more.

Scrolling with the scroll pad

- Move your finger down the scroll pad to scroll down through the contents of a window. Move your finger up the scroll pad to scroll up.

To use the Fn hot keys



The combination of the Fn key plus another key creates a *hot key*—a shortcut key sequence—for various system controls. To use a hot key, press *and hold* Fn, press the appropriate second key, and then release both keys.

This hot key	Does this
Fn+F1	Decreases the display brightness.
Fn+F2	Increases the display brightness.
Fn+F5	Toggles among the built-in display, an external display, and simultaneous display on both.
Fn+F8	Toggles the built-in keypad on and off. Does not affect an external keyboard. If Num Lock is on, then the numeric functions are active; otherwise, cursor control is active (as marked on an external keyboard).
Fn+F12	Enters Hibernate mode.
Fn+NumLock	Toggles Scroll Lock on and off.
Fn+Page Up	Increases the audio volume and cancels the mute setting.
Fn+Page Down	Decreases the audio volume.
Fn+Backspace	Mutes the audio output.

To use the One-Touch buttons

Your computer includes five One-Touch buttons that can start any application or open a document or Web site with a single press.

- Press the One-Touch button to open the corresponding application, document, or Web site.

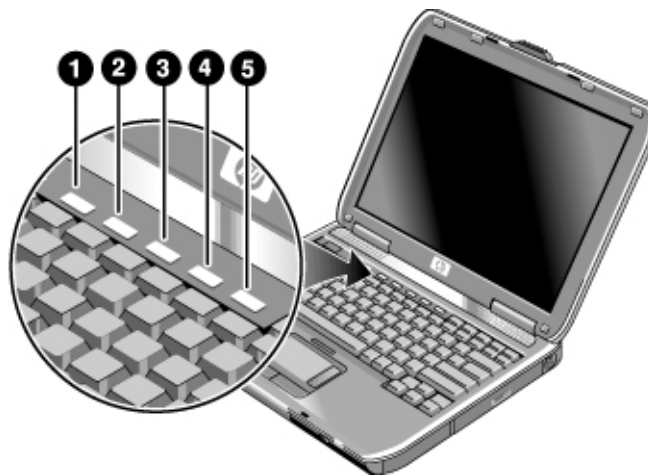

Your computer is preconfigured to access the following services:

1. Microsoft Outlook Express e-mail software.
2. HP TV Now—see “To use a TV set as a monitor” on page 83.
3. Microsoft Internet Explorer.
4. HP Quick Lock—see “To lock your computer” on page 39.
5. Microsoft Media Player.

–or–

Online notebook information.

To reprogram a One-Touch button

1. Click Start, All Programs, Hewlett-Packard, Notebook, HP One-Touch, HP One-Touch Configuration.
2. On the One-Touch tab, click the button you want to reprogram.

Basic Operation

Operating Your Computer

3. Type a label for the button, and then select the application, document, folder, or Web site you want the button to open.
4. If you want a label to appear onscreen when you press a One-Touch button, select that option on the Onscreen Display tab.

To use the Windows and Applications keys



The Windows key brings up the Windows Start menu. This is the same as clicking the Start button on the taskbar.



The Applications key brings up the shortcut menu for the current application. This is the same menu that appears when you right-click while pointing at the application.

This key combination	Does this
Windows key+E	Runs Windows Explorer.
Windows key+F1	Runs Windows Help.
Windows key+F	Runs Windows Find: Search.
Windows key+M	Minimizes all displayed windows.
Shift+Windows key+M	Returns all minimized windows to original size.
Windows key+R	Runs the Windows Run dialog box.

To use the embedded keypad

Your computer's built-in keyboard includes an embedded keypad you can use to type numbers and arithmetic operators. The keys in this keypad are marked using light blue characters.

- Press Fn+F8 to turn on the embedded keypad.
- Hold Fn while typing a key to turn the embedded keypad on temporarily.

When the embedded keypad is active, you can use Num Lock to change how the keypad functions:

- Num Lock on: the keys enter the numbers and arithmetic operators printed in light gold on the keyboard.
- Num Lock off: the keys act as cursor control keys, as marked on an external keyboard.

To use the ALT GR key

Non-U.S. keyboards have an ALT GR key to the right of the spacebar. This is a shift key that provides access to certain special keyboard characters.

- For a character in the lower-right corner of a key, press and hold ALT GR to type the character.



1. Shifted.
2. Unshifted.
3. ALT GR.

To adjust the display

Changing the brightness

- Press Fn+F1 or Fn+F2 to decrease or increase (respectively) the display's brightness.
- or–
- Click Start, All Programs, Hewlett-Packard, Notebook, HP Display Settings. You have the option of adding a display settings icon in the taskbar for quick access.

Hint

To maximize your battery operating time, set the brightness to the lowest level you can view comfortably.

Changing display settings

You can customize a number of display settings for your computer, such as color depth and screen area.

1. Click Start, Control Panel, Appearance and Themes, Display.
2. Click the Settings tab, and then choose the settings you want.

The computer has an LCD display, which behaves differently from a normal computer monitor. If you change the display resolution, the desktop changes size, but the objects on it do not. You normally won't change the resolution except to use an external monitor.

Changing icon and label sizes

If the icons and labels on your screen seem too small, you can enlarge them using HP Desktop Zoom.

- Click Start, All Programs, Hewlett-Packard, HP Desktop Zoom, HP Desktop Zoom.

Using an external monitor

If you want, you can attach an external monitor to your notebook computer. See "To use an external monitor" on page 82.

To adjust the volume

To increase or decrease the volume

- Press Fn+PageUp or Fn+PageDown.
- Press the back or front half of the volume control on the left side of the computer (certain models).
- Click the speaker icon in the taskbar (if not present, see Windows Help), and drag the volume control bar up or down.

To mute the audio

You can mute the audio output without changing the volume setting. This feature is handy when you want to block all speaker output regardless of what your computer is doing.

- Press Fn+Backspace.
- Press the audio mute button on the left side of the computer (certain models). The button lights when audio is muted.
- Click the speaker icon in the taskbar (if not present, see Windows Help), and click Mute.

To change computer settings for a presentation

When you show a presentation to an audience, you'll often want to adjust some of your video and power settings for the show. You can easily do this with HP Presentation Ready, an application that automatically adjusts your computer for slide shows and similar presentations, and also opens the presentation itself. Once the presentation is through, HP Presentation Ready automatically returns your computer to its normal settings.

To prepare for the presentation

1. Click Start, All Programs, Hewlett-Packard, HP Presentation Ready, Configure.

–or–

Click the HP Presentation Ready icon in the taskbar (if present), and then click Configure.

Basic Operation

Operating Your Computer

2. Select the presentation you want to show. If you don't select one, you can choose one when you start the show.
3. If you want to change the video or power settings for the show, click Settings.

To show the presentation

- Click Start, All Programs, Hewlett-Packard, HP Presentation Ready, Start Presentation.

–or–

Click the HP Presentation Ready icon in the taskbar (if present), and then click Start Presentation.

To adjust settings during the presentation, click the taskbar icon and choose Configure.

To end the presentation and restore the computer's normal settings, close the presentation application or click the taskbar icon and choose Stop Presentation.

Using CDs or DVDs

To insert or remove a CD or DVD

CAUTION

Do not remove a CD or DVD while the computer is reading it. Otherwise, the computer could stop responding and you could lose data.

Be sure to press the CD or DVD onto the spindle. You can damage the disk or drive if you just lay it on the tray.

1. Press the button on the face of the CD-ROM or DVD drive. If you are using this drive for the first time, be sure to remove the cardboard packing insert.
2. Place the CD or DVD into the drive (label facing up) and gently press down to seat it on the spindle.

–or–

Remove the CD or DVD.

3. Slide the tray back into the module to close it.

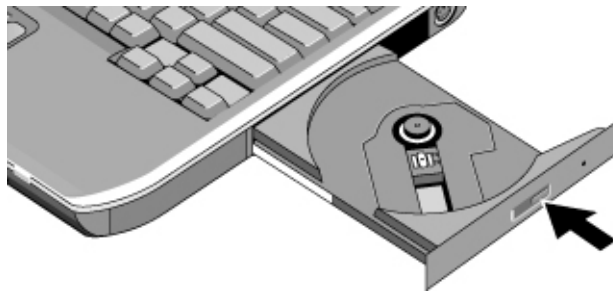

If your computer loses power, you can manually open the drive to remove a CD. Insert a straightened paper clip into the recessed hole on the front of the drive to open it.

To play DVD movies

If your computer came with a DVD drive, it also includes DVD player software that lets you play DVD movies.

- Click Start, All Programs, Multimedia, DVD Player, InterVideo WinDVD.

You can also use Windows Media Player to play DVD movies.

To play DVD movies on a TV, see “To use a TV set as a monitor” on page 83.

Hint

For best performance while playing movies on battery power, set the Control Panel power scheme to Portable/Laptop. See “How the computer manages power automatically” on page 48.

Important

DVDs can have regional codes embedded in the disc data. These codes prevent DVD movies from being played outside the region of the world in which they are sold. If you get a region code error, you are trying to play a DVD intended for a different region.

Most DVD drives let you change the region code only a limited number of times (usually no more than four). When you reach this limit, your last change to the region code will be hard-coded on the DVD drive, and will be permanent. Your HP warranty does not cover the expense of correcting this situation. Refer to the help for your DVD player software for details about setting region codes.

To create or copy CDs

If your computer came with a CD-RW drive, it also includes software that lets you copy or create CDs.

- Click Start, All Programs, Multimedia, CD Writer, RecordNow, RecordNow.

You can use Windows Media Player to create audio CDs, and Windows Explorer to create data CDs using a CD-RW drive.

Refer to the software’s help for details about creating or copying CDs. HP recommends using HP C4403A (CD-R) or C4404A (CD-RW) media—read and write quality may vary for other media.

Securing Your Computer

To set up password protection

You can protect your computer from access by another user when you set up password protection, which is available through Windows and through the BIOS Setup utility. For complete protection, set passwords in Windows as well as through BIOS Setup.

To cancel password protection, set an empty password.

BIOS Setup Utility

1. Click Start, Turn Off Computer, Restart.
2. When the HP logo appears, press F2 to enter BIOS Setup.
3. From the Security menu, enter or modify the Administrator Password or User Password as needed. See “Security Menu” on page 120.
4. Press F10 to save and exit BIOS Setup.

Windows XP

1. Click Start, Control Panel, User Accounts, and then select your account.
2. Click Create a Password, and then set the password.
3. Click Start, Control Panel, Performance and Maintenance, Power Options.
4. On the Advanced tab, select the option to prompt for a password when the computer leaves Standby mode.

To protect your computer when you're not using it, see “To lock your computer” below.

To lock your computer

To protect against unauthorized access while your computer is running, lock the computer before leaving it unattended, or set up a screen saver with a password in Control Panel Display. You can lock the computer these ways:

Basic Operation

Securing Your Computer

- Press the HP Quick Lock button—the five One-Touch buttons are located above the keyboard.
- or–
- Press CTRL+ALT+DEL and click Lock Computer. This option may not be available in all configurations.

To unlock the computer, follow your normal logon steps.

To attach a security cable

Your computer includes a built-in connector you can use to secure the computer with a cable and a lock (such as the Kensington MicroSaver lock system, available at many computer stores).

1. Wrap the cable around a secure object, such as a table leg.
2. Loop the cable to create a slip knot around the stationary object, and make sure it can't slip off.
3. Insert the lock into the security connector on the left side of the computer and release the key. Store the key in a safe place away from the computer.

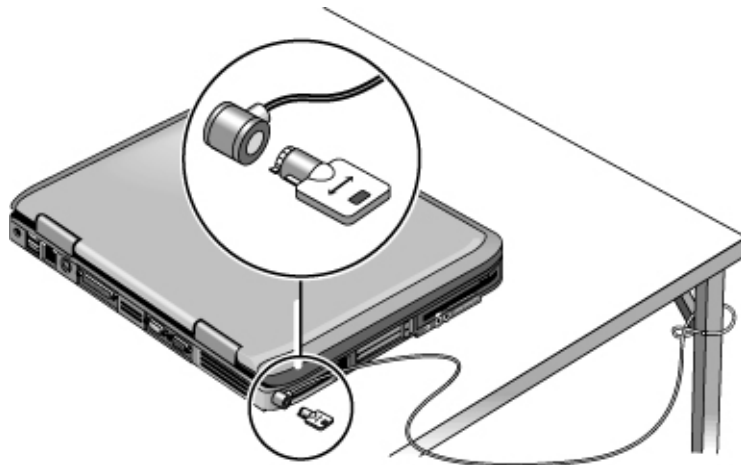

To protect against viruses

Virus-protection software can help protect the integrity of your data. This is especially important if you use the Web.

Your computer comes equipped with Norton AntiVirus software. You can get detailed instructions from the software's online Help.

To lock the hard disk drive

The computer enables you to lock its internal hard disk drive to help keep your information secure. *Hard disk drive lock does not protect a second hard disk drive installed in the module bay.*

CAUTION

When you enable hard disk drive lock, the current BIOS user password (or administrator password if that is the only password set) is encoded on the hard disk drive.

If you move the hard disk drive to another computer, you can't access the drive until you set the user (or administrator) password to match the drive's password. After you match the drive's password, you can change the computer (and drive) password. If you forget the password, you cannot recover your data.

-
1. Click Start, Turn Off Computer, Restart.
 2. When the HP logo appears, press F2 to enter the BIOS Setup utility.
 3. From the Security menu, enable Password Required to Boot.
 4. From the Security menu, enable Internal hard disk drive lock.
 5. Press F10 to save and exit BIOS Setup.

Working in Comfort with a Notebook PC

WARNING

Improper use of keyboards and other input devices has been associated with ergonomic injury. For more information about reducing your risk, visit our ergonomics Web site at www.hp.com/ergo—or see *Working in Comfort in the online HP Library*.

You can use your HP notebook computer virtually anywhere, anytime. The following recommendations should help you work more comfortably.

Note

If you are using your portable computer as your primary computer, or using it for extended periods, you should use it with a full-size keyboard, monitor, and mouse. This will give your portable computer the adjustability and comfort features of a desktop unit. HP docking accessories offer quick, easy connections to these devices. More information on how to prepare your workspace environment and set up your HP equipment is available in *Working in Comfort*, which is preloaded on the hard disk in the HP Library, and also available at www.hp.com/ergo.

Your Mobile Work Environment

- Use a chair that provides good support for your lower back. If an adjustable chair is not available, you can use a pillow or rolled-up towel to provide lower back support.
- Try to keep your thighs parallel to the floor and your feet flat on the floor. In a mobile environment, you can do this by using a phone book or briefcase to support your feet.
- Adjust the height of either your work surface or chair to keep your arms in a neutral position. Your arms should be relaxed and loose, elbows at your sides, with the forearms and hands parallel with the floor.
- Position your notebook computer display to minimize glare and reflection. For example, on an airplane, lower the window shade, or in a hotel room, draw the curtains. You also should maintain a comfortable viewing distance—approximately 40 to 60 cm (16 to 24 inches). Adjust the angle of your display to help keep your head angled slightly downward in a comfortable position.

Using Your Mobile Computer

- Position the computer so your wrists and hands are in a neutral position. Your wrists should be as straight as possible and should not have to bend sideways or more than 10 degrees up or down. If your notebook computer does not have a built-in palm rest, you can use a rolled-up towel.
- Try to type as lightly as possible. The notebook keyboard requires little force to activate.
- Take frequent, short rest breaks—this is especially important in a mobile computing environment.
- Portable computers weigh between approximately 1.4 and 3.7 kilos (3 and 8 pounds). When traveling, be sure to carry your computer properly to minimize strain on your body. Shift the bag containing your notebook equipment frequently between your left and right hands and shoulders.

Taking Care of Your Computer

Use the following recommendations to maintain your computer during everyday use and prevent potential physical damage or data loss.

To protect your hard disk drive

Hard disk drives, as well as other internal components, are not indestructible and can be damaged by inappropriate handling and operation.

- Avoid bumps or jolts.
- Do not operate the computer while traveling over bumpy terrain.
- Suspend or shut down the computer before transporting it. This turns off the hard drive. A drop of a few inches onto a rigid surface while the hard drive is operating could destroy data or damage the drive.
- Carry the computer in a padded case to protect against bumps and jolts.
- Set down the computer gently.

To maintain your computer

- Provide adequate ventilation around the computer. Always set the computer on a flat surface, so that air can flow freely around and underneath it.
- Always shut down the computer or put it in Hibernate mode before putting it in a carrying case or other enclosed space.
- Do not pick up or carry the computer by its display.
- Observe the temperature limits and other specifications listed in “Hardware Specifications” on page 134. Do not use the computer outside in the rain or snow (inclement weather). If the computer is cold, warm it gradually to avoid condensation.
- Maintain your battery for best performance—see “To get the most from your batteries” on page 52.

To safeguard your data

- Do not use a pointing device or activate any other device that interrupts operation while the system is starting or stopping.
- Back up your work regularly. Copy files to floppy, CD-RW, or network drives.
- Use a virus-scanning program (such as the Norton AntiVirus program included with your computer) to check the integrity of your files and operating system. Since new viruses appear frequently, you will also want to update the program's virus definitions from time to time; updates are on the Web at www.symantec.com for Norton AntiVirus.
- Check your disk using the Tools tab in the disk's Properties window.

To extend the life of the display

- Set the display brightness to the lowest comfortable level (Fn+F1).
- When working at your desk, connect an external monitor and turn off the internal display (Fn+F5).
- If you are not using an external monitor, set the Turn off monitor timeouts (for both AC and battery operation) to the shortest comfortable interval.
- Avoid using a screen saver or other software that prevents the computer from changing to Display-off or Standby mode after a timeout period. If you use a screen saver, enable the option to shut off the display after a time delay.
- Do not disable Display-off or Standby timeouts.
- If you are using AC power and have no external monitor attached, put the computer in Standby mode when not in use.

To clean your computer

- You can clean the computer with a soft cloth dampened with clean water or with water containing a mild detergent. Do not use an excessively wet cloth, and take care to keep water out of the case.
- Do not use abrasive cleaners, especially on the display. Do not apply any cleaner directly to the display. Instead, apply the cleaner to a soft cloth and then gently wipe the display.
- You can clean the keyboard with a vacuum cleaner to remove accumulated dust.

Batteries and Power Management

Managing Power Consumption

When you're running your computer on battery power, you will want to maximize operating time without compromising performance. Your computer is designed to help you reduce power consumption and extend battery life without needing to turn it off.

- During idle periods, the computer automatically enters power-saving modes after specified timeout periods. You can adjust these timeouts to suit your working habits.
- You can manually send the computer into a power-saving mode at any time by pressing the appropriate key—see “To manage power manually” on page 50.

How the computer manages power automatically

Your computer automatically enters Hibernate mode and Standby mode, and turns off the hard disk and display based on values set in Power Options in Control Panel.

Automatic action	Occurs after...	To resume...
Turns off hard disk. Turns off the hard disk drive. This is usually set to occur shortly after the display is turned off.	The hard disk is not accessed for the specified interval.	Begin using the computer: the hard disk turns on when needed.
Turns off display. Turns off the display to conserve battery power and extend the life of the display.	No keyboard, pointing device, or other input activity occurs for the specified interval.	Press any key or move a pointing device to turn on the display.
Enters Standby mode. Maintains your current session in RAM, and turns off the display and other components to conserve battery power.	No pointing devices are used, no disk drive is accessed, and no port (serial, parallel, or IR) is active for the specified interval.	Press the power button to return to your current session.
Enters Hibernate mode. Saves your current session to the hard disk, and then turns off the computer.	The computer stays in Standby mode for the specified interval.	Press the power button to restore your previous session.

CAUTION

Make a habit of saving your work before allowing your computer to enter Standby mode. If power is interrupted while the computer is in Standby mode, any information that was not saved will be lost.

The computer can also enter Hibernate mode if battery power reaches a critically low level. (See “To respond to a low-battery warning” on page 52.) If this happens, you will find on resuming that all your data has been saved, but some functions may be disabled. To resume normal operation, restore power by connecting an AC adapter or installing a charged battery, and then shut the computer off and restart it.

Changing timeout settings and creating power schemes

You can adjust the periods of non-use after which your computer automatically shuts down components or enters a power-saving mode. You can also save these settings as a power scheme.

1. Open Power Options in Control Panel: click Start, Control Panel, Performance and Maintenance, Power Options.
2. Click the Power Schemes tab, and enter the settings you want. If you don't want a particular timeout to occur, set the value to Never. See Windows Help for details.

If you want to save the settings as a power scheme, click Save As and enter a name for the scheme.

CAUTION

Do not disable Hibernate support in the Power settings, or you will lose any unsaved data if the computer's battery runs down completely.

Managing CPU power

If your computer contains a multispeed processor with AMD PowerNow! or Intel SpeedStep Technology, the processor can automatically switch to lower, power-saving speeds or to higher-performance speeds according to the workload.

You can customize CPU speed to best suit your working environment: click Start, Control Panel, Performance and Maintenance, Power Options. On the Power Schemes tab, select a power scheme. This scheme automatically controls the processor speeds:

- The Max Battery scheme uses the lowest processor speeds while running on battery power, but uses low and high processor speeds on AC power.
- The Portable/Laptop option uses low and high processor speeds on battery and AC power.
- The Presentation option uses the lowest processor speeds on battery power, but uses low and high processor speeds on AC power.

See Windows Help for additional information about power schemes.

Batteries and Power Management

Managing Power Consumption

To manage power manually

In addition to allowing the computer to enter its power-saving modes automatically, you can also put it into any of the following three modes whenever you need to.

Power mode	Does this...	Use when...	To enter this mode...
Standby	Maintains your current session in RAM, and turns off the display and other components.	You will be away from your computer for up to several hours.	Press the power button –or– click Start, Turn Off Computer, Stand By.
Hibernate	Saves the current session to disk, and then shuts down. Provides maximum power savings while still allowing you to recover the current session.	You will be away from your computer for a day or more, but want to continue your session.	Press Fn+F12.
Off	Turns off your computer, providing maximum power savings. The current session will not be saved, and any unsaved data will be lost.	You're done with your work.	Click Start, Turn Off Computer, Turn Off –or– press the power button (only if the Start menu procedure doesn't work).

You can also turn off the display by closing the lid.

Using Battery Power

To check battery status

From the battery status light

Your computer has a battery status light—see “Status Lights” on page 17.

From the Windows taskbar

The Windows taskbar can display a power icon that provides detailed battery status information (see Windows Help for details). The icon looks like a battery when AC is not connected.

- Place the pointer over the power icon to display the remaining battery charge. This value is shown as either a percentage of charge remaining, or as time remaining.
- Double-click the power icon to open the Battery Meter window.

From the Windows Control Panel

- Click Start, Control Panel, Performance and Maintenance, Power Options, and then click the Power Meter tab to see the battery status. The Alarms and Advanced tabs provide additional Windows’ power-information options.

On the battery

1. Remove the battery from the computer—see “Step 1: Install the battery” on page 19.
2. Press the contact pad on the side of the battery. The number of lights that turn on indicates the remaining charge (each light represents 20% of a full charge).

To respond to a low-battery warning

The computer automatically alerts you when the battery power drops to a critically low level. The computer first emits a high-pitched beep or displays a warning message. Then, if you do not restore power within a short time, the computer goes into Hibernate mode.

Once the computer enters Hibernate mode in this way, you won't be able to turn it on again until you restore power by doing one of the following:

- Replace the battery with a charged one. See “Step 1: Install the battery” on page 19.
- Plug in the AC adapter. See “Step 2: Connect AC power” on page 21.

Note

If you plug in the AC adapter, you can continue to work while your battery recharges.

To recharge the battery

CAUTION

The AC adapter is normally warm whenever plugged into an AC outlet. The computer is normally warm while recharging. Don't recharge the computer in a briefcase or other confined space, or its battery could overheat.

- Plug the AC adapter into the computer.

To get the longest operating time, wait until the battery's charge is below 50% before recharging, and then charge it fully (100%). Charging can take up to approximately 2 hours. If you continue working while the battery charges, the charging time may increase to 3 hours.

A fully charged battery can operate the computer for up to 2 to 3 hours, depending on your computer's model, power management settings, and level of use.

To get the most from your batteries

Follow these suggestions to make your battery's power last as long as possible.

- Plug in the AC adapter, especially when using a CD-ROM or DVD drive, or any external connections such as a PC Card or a modem.
 - Set the display brightness to the lowest comfortable level (Fn+F1).
-

- Put the computer in Standby mode whenever you are not using it for a short while: press the power button, or click Start, Turn Off Computer, Standby.
- Put the computer in Hibernate mode whenever you want to save your current session, but will not be using the computer for a day or more: press Fn+F12.
- Set the automatic timeout settings to emphasize saving power. If your computer has a multispeed processor, use the lower speed on battery power (the default settings conserve battery power)—see “How the computer manages power automatically” on page 48.
- If your computer has a wireless on-off button, turn off the wireless function when you’re not using it. Press the wireless on-off button so the light turns off.
- If your model has technology code KB (shown on the serial number label), check that the display is using the Powerplay option. In Control Panel Display, on the Settings tab click Advanced, and then on the Powerplay tab check whether Powerplay is enabled. This allows the computer to save power when it’s not needed by the display.
- If you have an I/O PC Card—that is, a PC Card having an external connection, such as a network card—remove it when you’re not using it. Some I/O cards use significant power even while they’re inactive.
- If you work with an application that uses the serial port or an I/O PC Card, exit the application when you finish using it.

In addition, follow these suggestions to extend the life of your batteries.

- Do not leave batteries unused for long periods. If you have more than one, rotate them.
- If you normally use AC power, make a practice of using the battery as your power source at least once a week.
- Unplug the AC adapter when the computer is not in use.
- To preserve the life of a battery, be sure to charge it regularly.
- For long-term storage, the battery must be charged 20–50% to minimize capacity loss by self-discharge and to avoid deterioration of battery performance.
- To maintain maximum battery capacity and accuracy of the battery gauge, perform this calibration procedure every few months:
 1. Click Start, All Programs, Hewlett-Packard, Notebook, HP Battery Optimizer.
 2. Follow the displayed instructions to test and condition your battery. The process could take 4–6 hours or more per battery. You can use the computer during the process. If you interrupt the process, the battery might be left with a low charge.

Modem and Network Connections

Using the Modem

If your computer has a modem port, you can connect your modem to a telephone line and communicate with other computers throughout the world. You can explore the Internet, send and receive e-mail messages, and use your PC to send and receive faxes. Your computer contains several software programs that work with your modem:

- Internet Explorer, for browsing the World Wide Web
- Outlook Express, for sending and receiving e-mail messages
- Windows XP Fax Console software for sending and receiving faxes

The modem is a high-speed 56-Kbps modem. For best performance, you can connect to any Internet Service Provider (ISP) or modem network that has V.90 or V.92 interoperable modems. Check with your ISP for a list of telephone numbers that support V.90 or V.92.

The maximum speed for faxing is 14.4 Kbps. Even though the modem is capable of downloading at 56 Kbps, your ISP or modem network may not operate at this speed or support this technology. Please check with your service provider for information on its capabilities. Furthermore, download transmission rates depend on the condition of the telephone line.

To connect the modem

CAUTION

To reduce the risk of fire, use only No. 26 AWG or larger telecommunications line cord to connect the modem to the telephone wall jack.

1. Check that the telephone line is an analog line, sometimes called a data line. (You must not use a digital line.)
2. Connect a telephone cord with an RJ-11 plug into a telephone jack. If the plug on the phone cord doesn't fit the jack, you may need to use an adapter.
3. Plug the other end of the phone cord into the built-in modem.

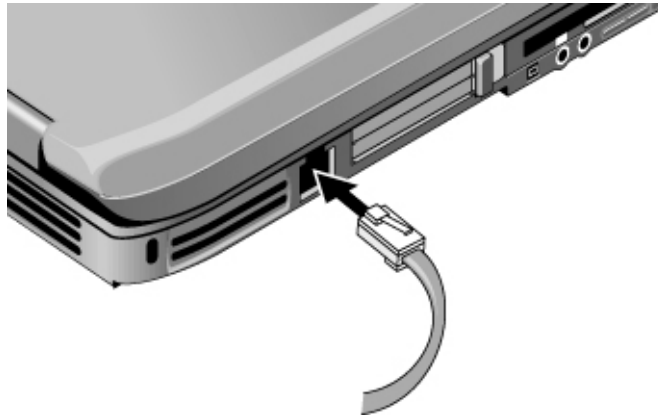

4. Check your modem's country or region settings: click Start, Control Panel, Printers and Other Hardware, Phone and Modem Options.

CAUTION

Your built-in modem may not work with multiple phone lines or a private branch exchange (PBX), cannot be connected to a coin-operated telephone, and does not work with party lines. Some of these connections may result in excess electrical voltage and could cause a malfunction in the internal modem. Check your telephone line type prior to connecting your phone line.

Special restrictions in certain countries

- Many countries impose a blackout period after a modem repeatedly fails to connect to a service provider. The number of failed attempts and the period you must wait before trying again differ from country to country: check with your telephone company.

For example, if you are dialing from Italy and fail to connect to your server or cancel the connection, you must wait one minute before dialing that number again. If you dial before then, you will get an error message that says "delay." After the fourth

Modem and Network Connections

Using the Modem

failed connection, you must wait one hour before trying the number again. If you dial before the hour is up, you will get a message that says “black list.”

- When using a modem in the Republic of South Africa, an external surge protector may be necessary in order to prevent computer damage by lightning or other electrical surges. Connect any approved surge protector to the modem cable whenever you are using the modem.

To connect to the Internet

Signing up with an Internet Service Provider

Before you can connect to the Internet, you need to set up an account with an Internet Service Provider (ISP). For some countries and models, Hewlett-Packard provides easy Internet signup so that you can connect quickly to an ISP.

1. Connect your built-in modem—see the previous topic. (If your computer does not have a built-in modem, you can instead use a PC Card modem or an external modem.)
2. If available, double-click the Connect to the Internet or Easy Internet Signup icon on the desktop. This launches the Internet Connection or New Connection wizard, which helps you locate an ISP in your area, transfer an existing Internet account to this computer, or set up an Internet connection manually.

–or–

If available, click Start, All Programs, Online Services, or click Start, All Programs, Easy Internet Signup, and select one of the listed ISPs. This begins the registration process for the ISP you choose.

Connecting to the Internet

1. Double-click the Internet Explorer icon on the desktop. For your first connection, you’ll be prompted for information about your connection.
2. Click the Connect button in the Dial-up Connection or Network Connections window.

To display an icon for your connection, open Network Connections in Control Panel, right-click the connection, select Properties, and select the icon option.

To disconnect from the Internet

You remain connected to the Internet until you shut down the computer, disconnect the phone line from the computer, or give a command to hang up the connection.

- Click Start, Control Panel, Network and Internet Connections, Network Connections, and then right-click the connection and select Disconnect.

–or–

Double-click the connect icon in the taskbar, and click Disconnect. (You can enable this icon as described in “To connect to the Internet,” above.)

To dial in to a network

You can use the modem to dial in to a LAN (local area network) that supports dial-in connections. This gives you access to network resources from a remote location.

- See Windows Help for information about setting up and using dial-in network connections—click Start, Help and Support.

To change your modem settings

The modem is already set up to be compatible with telephone systems and modems in most areas. However, in some situations, you may have to change modem settings to match local conditions. If you have questions about local requirements, contact your telephone company.

- **Control Panel.** Open Phone and Modem Options in Control Panel to change many modem settings. On the Modems tab, click Properties to set connection speeds, or on the Dialing Rules tab click Edit to set dialing options.
- **Communications software.** Many communications applications provide options for controlling modem settings. See the help for your software.
- **AT commands.** You can control many aspects of modem operation using modem AT commands. AT commands are special strings of characters sent to the modem to set up specific conditions. Those command strings normally start with “AT”. For a list of AT commands for the built-in modem, see “Modem Reference Information” on page 138.

Open Phone and Modem Options in Control Panel. On the Modems tab, click Properties. You can type AT commands on the Advanced tab in the space for extra settings.

For example, to force a built-in modem to turn off its speaker, you can use the M0 command as shown in table of AT commands—type ATM0 in the space for extra settings.

To send and receive e-mail

Sending and receiving e-mail requires an e-mail account with an Internet Service Provider or with your company's communications system. If you are using AOL, e-mail services are part of your AOL service. For another ISP, you can use Outlook Express (included with your computer) or an e-mail system of your choice. This topic includes instructions for using Outlook Express.

To start Outlook Express

1. Click Start, All Programs, Outlook Express, or double-click Outlook Express on the desktop (if available).
2. If you are not currently connected to the Internet, the Dial-up Connection window appears. Choose Connect to connect to the Internet.

To send an e-mail message

1. In Outlook Express, click the New Mail or Create Mail tool on the toolbar.
2. Fill in the information in the New Message window.
3. When you're finished, click the Send button.

To receive e-mail messages

1. In Outlook Express, click the Send/Recv tool on the toolbar to have Outlook deliver new messages.
2. Click the Inbox folder to view the list of messages. Unread messages appear bold on the screen.
3. To view a message, click it once. (Or double-click to view the message in its own window.)

To send and receive faxes

Sending and receiving faxes requires just a telephone connection—you don't need an Internet connection. You can use the modem and fax software to send and receive faxes on your computer. Fax Console fax software is included with Windows XP.

To set up Fax Console

Before you can use Fax Console, you need to install it.

1. Click Start, Control Panel, Add or Remove Programs.
2. Click Add/Remove Windows Components, select Fax Services, and follow the instructions on the screen. If prompted for the Windows CD, point instead to the c:\i386 directory.

To start Fax Console

- Click Start, All Programs, Accessories, Communications, Fax, Fax Console.

The first time you start Fax Console, the Fax Configuration Wizard steps you through the process of setting options and customizing the program for your personal use. Follow the onscreen instructions. If you're not sure which setting to choose, accept the default choice.

To send a fax

- Click Start, All Programs, Accessories, Communications, Fax, Send a Fax, and then follow the instructions that appear on the screen.

If instead you want to send a document as a fax, open the document in its application window, and then open the Print dialog box. Change the selected printer to Fax, and then print it.

To receive faxes

Faxes are automatically received when Fax Console is running in an open or minimized window. New faxes are indicated in the status box in the Fax Console window. To receive a fax manually:

- When a fax call is coming in, click Receive now on the Fax Console menu bar.

To view and print a fax

1. In the Fax Console tree, click Inbox, and then double-click the fax you want to view.
2. Click the printer icon to print the fax.

Connecting to a LAN

If your model has a LAN port, you can connect to local area networks (LANs). LANs give you access to network resources, such as printers and file servers on your corporate network, and possibly to the Internet.

To connect to a LAN

1. Check that the existing LAN supports Ethernet 10Base-T (10 Mbps) or 100Base-TX (100 Mbps) connections.
2. Plug the LAN cable (not supplied) into the built-in LAN port. The cable must have an RJ-45 connector.
3. Windows automatically detects and sets up a LAN connection. To edit settings, open Network and Dial-up Connections in Control Panel.

See Windows Help for information about setting up and using LAN connections—click Start, Help and Support (or Help). Contact your network administrator for network information.



Two lights next to the LAN port indicate the status of the connection:

- The yellow light indicates network activity.
- The green light indicates a 100 MB per second link.

Making Wireless Network Connections

If your computer includes a wireless on-off button—located on the right side of the front of the computer—you can connect by radio to an 802.11 wireless local area network (LAN) and access computers and other resources on the network.

A wireless network provides all the functions of a typical “wired” network, but also provides for “roaming.” Since your computer connects to the network by radio rather than through cables, you can move from place to place within the network—from your office to a conference room, for example—and remain on the network the entire time.

To prepare for connections

Before you can connect your computer to a particular 802.11 wireless network, you have to configure the computer for the specific wireless connection.

Connecting to an Existing Wireless Network

You can connect to an access point that gives you access to a local area network, or you can connect directly to other computers in an “ad hoc” network.

1. Right-click the wireless network connection icon in the taskbar, and then select View Available Wireless Networks from the pop-up menu.
2. A list of available networks appears. Select the network you want, enter the encryption key if required, and click Connect.

If the network you want is not on the list, click Advanced, Configure, and enter the required network parameters. If the network is not using 802.1x authentication protocol, clear the automatic key option.

3. On the General tab, edit network settings as needed for your local network. See your network administrator. You can also display an icon in the taskbar when connected to a network.
4. On the Wireless Networks tab, view the wireless networks available within range. Each network SSID is listed. Click the network you want and click Configure.
5. If the wireless network uses standard encrypted communication, uncheck the automatic key option, and then select the following parameters—see your network administrator for the required settings:
 - Key: ASCII passphrase or hexadecimal key string.

- Key format: ASCII for passphrase, hexadecimal for key string.
 - Key length: smaller number for 64-bit encryption, larger number for 128-bit.
6. Click OK to save the configuration. This network is added to your list of preferred networks.

The computer automatically connects to the first preferred network that's within range if wireless communication is turned on—see “To turn wireless communication on and off” on page 66.

Creating a New Computer-to-Computer Network (AdHoc)

You can set up a new network available to other local computers.

1. Click Start, Control Panel, Network and Internet Connections, Network Connections.
2. Double-click the wireless connection to show its status, and then click Properties.
3. On the Wireless Networks tab, click Add to create a new network.
4. Type a name for the new network.
5. If you want to use encrypted communication, uncheck the automatic key option, and then select the following parameters:
 - Key: ASCII passphrase or hexadecimal key string.
 - Key format: ASCII for passphrase, hexadecimal for key string.
 - Key length: smaller number for 64-bit encryption, larger number for 128-bit.
6. Mark the option to make this a computer-to-computer (adhoc) network.
7. Click OK to save the configuration. This network is added to your list of preferred networks and becomes available to other computers.

To turn wireless communication on and off

Important

Wireless networks and cellular modems are examples of devices that use wireless communication. Such devices may be restricted in some situations or environments, such as when traveling in an airplane. If in doubt, be sure to ask for authorization *before* turning on your computer's wireless networking.

In Italy, Singapore, and possibly other countries, you may be required to ask the responsible authority for a license paid for by you before using the wireless function.

Turning on communication and making a connection

If your computer has both wireless 802.11 and Bluetooth capabilities, the wireless indicator light on the front of the computer turns on when Bluetooth or 802.11 communication is turned on, but it doesn't show whether Bluetooth, 802.11, or both functions are active. You must use HP Wireless Configuration to control the individual wireless functions.

1. If the computer isn't on, turn it on.
2. If you normally press the wireless on-off button on the front of the computer to turn wireless 802.11 communication on and off, press the button so the indicator light turns on. This restores your previous wireless configuration.

–or–

Click Start, All Programs, Hewlett-Packard, Notebook, HP Wireless Configuration, then click the 802.11 button to turn on wireless 802.11 communication.

–or–

Click Start, Control Panel, Network and Internet Connections, Network Connections, and then double-click the wireless network connection icon.



If you're within range of your wireless network, your computer automatically connects. To check the status of your wireless connection, open Network Connections in Control Panel and double-click the connection.

Turning off communication and ending a connection

1. **Important:** close any files that reside on other network computers.
2. To turn off the wireless 802.11 communication without turning off the computer, press the wireless on-off button—this also turns off Bluetooth communication if it was enabled.

–or–

Click Start, All Programs, Hewlett-Packard, Notebook, HP Wireless Configuration, then click the 802.11 button to turn off wireless 802.11 communication—without affecting Bluetooth communication.

–or–

Right-click the wireless network connection icon in the taskbar and select Disable.

Suspending or shutting down the computer also turns off the wireless function.

Making Wireless Bluetooth Connections

If your computer includes Bluetooth wireless capabilities, you can use it to make short-range radio connections to a wireless personal area network (PAN) and access other Bluetooth-compatible devices, such as other computers, cell phones, and printers.

Since the Bluetooth function connects your computer by radio rather than through cables, you can move around and remain connected, and you can detect new Bluetooth devices automatically when they enter your area.

To turn Bluetooth communication on and off

Important

Wireless communication may be restricted in some situations or environments, such as when traveling in an airplane. If in doubt, be sure to ask for authorization *before* turning on your computer's wireless networking.

In Italy, Singapore, and possibly other countries, you may be required to purchase a license from the responsible authority before using the wireless function.

Turning on Bluetooth communication

The wireless indicator light on the front of the computer turns on when Bluetooth or 802.11 communication is turned on, but it doesn't show whether Bluetooth, 802.11, or both functions are active. You must use HP Wireless Configuration to control the individual wireless functions.

1. If your computer isn't on, turn it on.
2. If you normally press the wireless on-off button on the front of the computer to turn Bluetooth communication on and off, press the button so the indicator light turns on. This restores your previous wireless configuration.

–or–

Click Start, All Programs, Hewlett-Packard, Notebook, HP Wireless Configuration, then click the Bluetooth button to turn on Bluetooth communication.

–or–

If the HP Wireless Configuration icon is present in the taskbar, double-click the icon, then click the Bluetooth button to turn on Bluetooth communication.



Turning off Bluetooth communication

Turning off communication ends any connection you have open.

1. **Important:** close any files that reside on other network computers.
2. To turn off Bluetooth communication without turning off your computer, press the wireless on-off button—this also turns off 802.11 communication if it was enabled.

–or–

Click Start, All Programs, Hewlett-Packard, Notebook, HP Wireless Configuration, then click the Bluetooth button to turn off Bluetooth communication—without affecting 802.11 communication.

–or–

If the HP Wireless Configuration icon is present in the taskbar, double-click the icon, then click the Bluetooth button to turn off Bluetooth communication—without affecting 802.11 communication.

Turning off the computer or putting it into hibernation also turns off the Bluetooth function.

To prepare for Bluetooth connections

Before you use your computer to access other Bluetooth devices, you should configure some basic settings.

1. Make sure Bluetooth communication is turned on—see the previous topic.
2. Double-click the Bluetooth icon in the taskbar.
3. In the menu bar, click Bluetooth, Device Configuration. (This menu is available only while Bluetooth folders are selected.)
4. On the General tab, check the following settings:
 - Give your computer a unique name that will identify it to other Bluetooth users.
 - Set the computer type to Laptop.
 - Select the security mode you want to use.
5. On the Information Exchange tab, check the following settings:
 - Check the directory you want to make available to other Bluetooth users for sharing files, both sent and received.
 - Check the directory where you want to store your business card file so you can easily send it to other Bluetooth users.
 - Check the inbox directory where you want delivered files from other Bluetooth users to be stored automatically.

Detailed information about these and other advanced settings are included in the online help.

To create your business card, you can open Microsoft Outlook, then open the address book and create a new contact. After entering your personal information, click File, Export To vCard File and store the file in your business card directory.

To send or receive files using Bluetooth

If your computer includes Bluetooth wireless capabilities, it supports the following common protocols for transferring data. To use either protocol, *both* computers must support that protocol—check the other computer’s Bluetooth documentation.

- FTP, meaning files can be copied into and out of shared directories (folders) by both computers. This service is equivalent to common network file sharing.
- OPP (object push profile), meaning both computers can send certain types of Microsoft Outlook data to the other computer’s Bluetooth inbox, but cannot retrieve files from the other computer.

Sharing files with another Bluetooth device (FTP)

1. Double-click the Bluetooth icon in the taskbar.
2. In My Bluetooth Places, select and open the other device to view files in its shared directory.
3. Use Windows Explorer or other software to copy or move files between your computer and other other device.

Sending Outlook data to another Bluetooth device (OPP)

1. Double-click the Bluetooth icon in the taskbar.
2. In My Bluetooth Places, select and open the other device.
3. To send a calendar item, note, or message, right-click the device’s inbox and select the option you want, then select the file to send. The file arrives in the device’s inbox directory.

–or–

To send your business card, right-click the device’s inbox and select the option to send your business card.

To connect to a Bluetooth printer or serial device

You can connect your computer to a Bluetooth serial device—for example, you could print from a word processor to a Bluetooth serial printer.

1. Make sure Bluetooth communication is turned on—see “To turn Bluetooth communication on and off” on page 68.
2. Install the printer software that comes with the Bluetooth printer. The following details are for the HP Deskjet 995C printer:
 - a. Insert the CD that came with the printer. If the setup program doesn't run, click Start, Run and run \setup.exe on the CD.
 - b. When prompted, click the option for installing the printer software. Follow the displayed instructions. For each screen, click the right arrow to continue.
 - c. When prompted to select how the printer is connecting, select the Bluetooth option.
 - d. When you reach the Bluetooth information screen with no right arrow, click the X to exit.
3. Double-click the Bluetooth icon in the taskbar.
4. In the menu bar, click Bluetooth, Device Configuration. (This menu is available only while Bluetooth folders are selected.)
5. On the Client Applications tab, find the Bluetooth serial port and note the name of the COM port at the far right, such as COM4. You can also create new COM ports for multiple serial devices.
6. After writing down the COM port number, close the Bluetooth configuration window.
7. Click Start, Printers and Faxes.
8. Right-click the printer icon for the Bluetooth printer and select Properties.
9. On the Ports tab, find the Bluetooth COM port you noted above, click the box next to the port name so it is checked, then click OK. This enables access to the printer via the Bluetooth serial port.
10. Double-click the Bluetooth icon in the taskbar.
11. In the menu bar, click Bluetooth, Search For Devices.

12. Double-click the printer icon for the Bluetooth printer you want to use, then double-click the serial port icon that is shown. When you see a message confirming this printer will use the Bluetooth COM port, click OK.

Whenever you print to this printer, it will use the Bluetooth connection you established.

To make a dial-up connection via a Bluetooth phone

If you have a Bluetooth cellular phone, you can use it with your computer to make a dial-up connection to your Internet service provider.

1. Make sure your Bluetooth phone is available for connection—see the manufacturer’s instructions. Some phones must be set for detection and may be detectable by other Bluetooth devices for only a short time.
2. On the computer, double-click the Bluetooth icon in the taskbar, then select Entire Bluetooth Neighborhood.
3. In the menu bar, click Bluetooth, Search For Devices.
4. In the left half of the window, double-click the Bluetooth phone to discover its available services.
5. Optional: In the left half of the window, right-click the Bluetooth phone and select Pair Devices, then type a passkey on the computer and phone when prompted. Some phones may require this step. For others, this keeps the phone on your list of Bluetooth devices for future use.
6. In the right half of the window, double-click Dial-Up Networking.
7. When prompted, type your user name, password, and phone number to dial., then click Dial.

To close the dial-up connection, click the Bluetooth phone in the left side of the Windows Explorer window, then in the right half of the window right-click Dial-Up Networking and select the option to disconnect.

Add-On Devices

Connecting PC Cards

The computer's PC Card slot is available for storing data and expanding the communication capabilities of the computer. The computer supports standard Type II and III PC Cards (PCMCIA and CardBus). If your model has two eject buttons, you can insert two Type II cards or one Type III card. If it has only one button, you can insert one card of any type.

To insert or remove a PC Card

Inserting a PC Card

1. Hold the PC Card with its face up and its connector holes toward the card slot.
2. Slide the PC Card all the way into the slot. Most cards are properly seated when the outer edge is flush with the casing of the computer, but some cards are designed to protrude from the case.

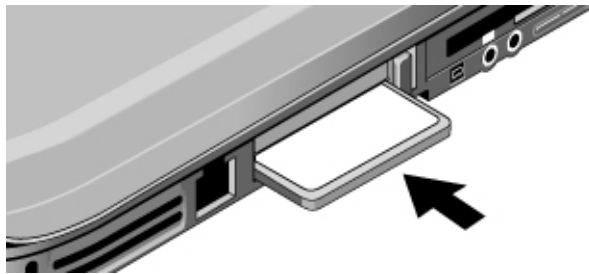

Removing a PC Card

CAUTION

Before removing a PC Card, you must use the Eject Hardware or Safely Remove Hardware icon in the taskbar, or shut down the computer. Otherwise, you could lose data.

1. Before removing the card, click the Eject Hardware or Safely Remove Hardware icon in the taskbar, and then click the card you want to remove. This protects your data and helps avoid unexpected problems.



If needed, you can restart the card by removing and then reinserting it.

2. Press the eject button to pop the button out, and then press it in to eject the PC Card.

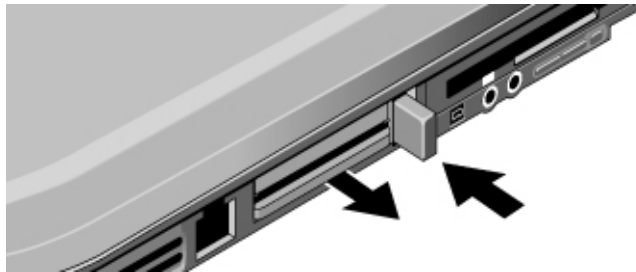

Connecting External Devices

To identify connectors for external devices

The diagrams below show your computer's connectors for external devices and for the port replicator.

Locating connectors on the computer

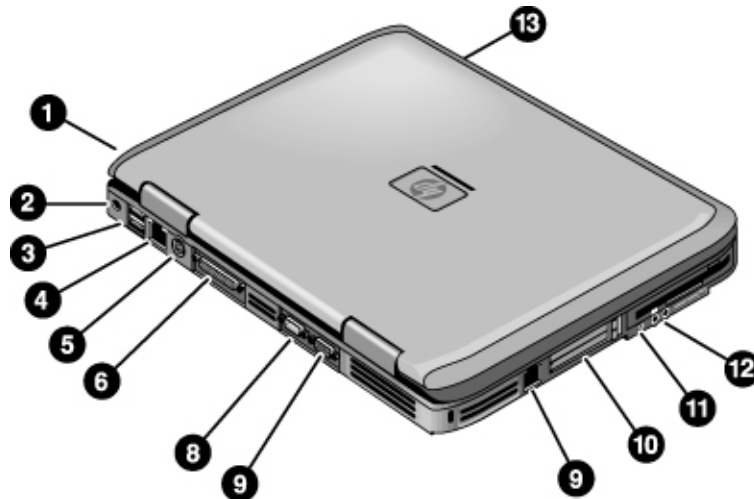

1. PS/2 keyboard or PS/2 mouse port (supports Y adapter).
2. AC adapter jack.
3. Two universal serial bus (USB) ports.
4. LAN port (on certain models).
5. S-video port (on certain models).
6. Parallel port (LPT1). Use this port for a parallel printer or other parallel device.
7. Serial port (COM1).
8. External monitor port.
9. Modem port (on certain models).

10. PC Card and CardBus slot. See “Connecting PC Cards” on page 76.

11. IEEE 1394 port (on certain models).

12. Audio ports.

13. Infrared port (on certain models).

Locating connectors on the port replicator

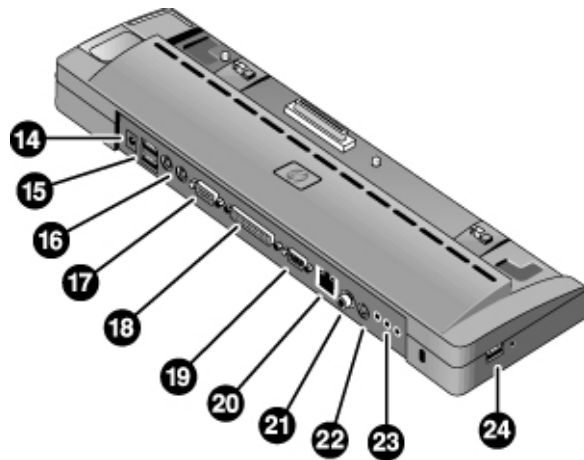

14. AC adapter jack.

15. PS/2 keyboard and PS/2 mouse ports.

16. USB ports.

17. External monitor port.

18. Parallel port.

19. Serial port.

20. LAN port (works only if the computer has a built-in LAN port).

21. Digital audio port (SPDIF).

22. S-video port.

23. Audio ports (microphone, headphone, line-in).

24. USB port.

Add-On Devices

Connecting External Devices

Note

Before you connect any device, check its documentation to see if you need to make any settings or adjustments to the equipment before using it. This might include setting switches to configure the equipment so that it will operate properly with your computer and the software you plan to use.

To connect a printer or other parallel device

The computer's parallel port uses a standard 25-pin connector, most commonly used for connecting dot-matrix, ink-jet, and laser printers. You can also use it to connect a parallel Zip drive.

- Connect the cable from the parallel printer or other parallel device to the computer's parallel port.

To connect an external keyboard or mouse

- Plug a USB mouse or keyboard into a USB port.
- or–
- Plug a PS/2 mouse or keyboard into a PS/2 port.

The pointing stick and touch pad are normally disabled while an external PS/2 mouse is connected.

To connect a PS/2 mouse and keyboard at the same time, use the HP F1469A Y adapter.

To connect a USB device

Your computer's universal serial bus (USB) provides a bi-directional serial interface for adding peripheral devices such as game controllers, serial and parallel ports, and scanners on a single bus.

- Attach the device's USB cable to one of the USB ports. Windows automatically recognizes the USB device. Some USB devices can be connected to the computer in series—this is called a daisy-chain connection.

Note

If you have problems making this connection, contact the device manufacturer and the HP Business Support Web site (www.hp.com/go/bizsupport) for the latest version of the driver for the device.

To connect an audio device

If your model has a built-in microphone—look for a microphone icon near the right click button on the touch pad—you can use it to record voice, sound, and music. You can also plug in an external microphone, external speakers, or headphones. In addition, if you connect your computer to the port replicator, you can plug in a stereo source (such as a CD player) or a device that accepts digital audio (such as a digital audio recorder).

CAUTION

The headphone and line-in jacks are three-terminal stereo jacks. They are not compatible with two-terminal mono plugs. Connecting a mono plug into either of these jacks may damage the computer.

- Attach the audio cable to the corresponding audio port on the computer or port replicator.

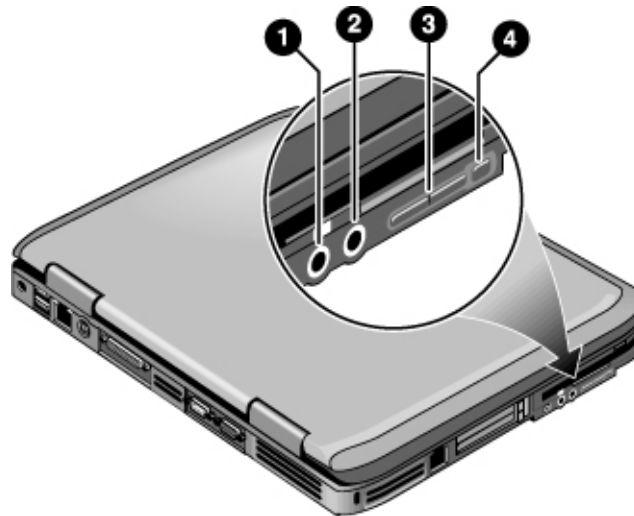

1. External microphone.
2. Audio out (headphones).
3. Volume control (on certain models).
4. Audio mute button and audio mute light (on certain models).

Add-On Devices

Connecting External Devices

Note

If your model has a built-in microphone and you plug a device into the external microphone port, the built-in microphone automatically turns off. When you plug a device into the headphone port, the built-in speakers automatically turn off. When you plug a device into either audio port on the computer, any device connected to the corresponding port on the port replicator is ignored.

To use an external monitor

Connecting an external monitor

1. Click Start, Turn Off Computer, Turn Off.
2. Connect the monitor cable from the monitor to the monitor port on the back of the computer.
3. Connect the monitor to a power source and turn it on.
4. Press the power button to turn on the computer.

Switching the display to the external monitor

- Press Fn+F5 to cycle through the display options: notebook display, external monitor, both.

–or–

Click Start, All Programs, Hewlett-Packard, Notebook, HP Display Settings.

You can also add a display settings icon in the taskbar for quick access.

- If you need to use both displays at once, press Fn+F5 repeatedly until the image shows on both displays. With the default display settings, the external monitor uses the same settings as the internal display. The external monitor displays the same image as the internal display, regardless of the screen area, colors, and other settings, and the refresh rate is the same for as the internal display (60 Hz). If you use only the external monitor, you can select different settings that aren't limited by the internal display.

Adjusting monitor resolution and other settings

1. Click Start, Control Panel, Appearance and Themes, Display.
2. On the Settings tab, adjust the Screen area. Other settings are also available.

For high-resolution external monitors, see “Hardware Specifications” on page 134 for the maximum supported resolutions, colors, and refresh rates. The capabilities of external

monitors vary greatly, and the display quality of your monitor may not be optimal at higher settings.

If you need to increase the refresh rate on the external monitor, you can switch to only the external monitor. An alternative is to make one display a “secondary” display so you can select independent refresh rates:

1. Click Start, Control Panel, Appearance and Themes, Display.
2. On the Settings tab, click the Advanced button, and then the Displays or Monitor tab. Set the refresh rate on the Monitor tab.

Using dual display mode

You can extend your desktop by connecting an external monitor to your computer.

1. Click Start, Control Panel, Appearance and Themes, Display.
2. Click the Settings tab.
3. Click the second display, and then select the option to extend the desktop.

You can set different resolutions and numbers of colors for each display. However, using the Extended Desktop requires video memory for each display. For this reason, higher resolutions and higher numbers of colors may cause unexpected behavior on the displays. Try starting with 1024 × 768 resolution on the external display and 64 K colors (16-bit) on both displays. You can then try higher settings to see whether they work for your applications. In addition, certain operations such as playing DVDs and running 3D graphics require extra video memory, so you may have to adjust display settings.

If you’re playing a DVD movie, the movie will show only on the primary display. To change the primary display, go to the Settings tab of Display Properties (see the steps above), right-click the display you want, and select Primary.

To use a TV set as a monitor

If your model has an S-video port on the back, you can connect a television set or other video device to your computer to use as a display.

To connect a TV set

1. Connect the TV set to the S-video port using a standard S-video cable, or a composite-video adapter with a standard RCA-type video cable.

For best quality and operation, use a TV with an S-video input and connect an S-video cable from the computer to the TV. If the only connection available is a

Add-On Devices

Connecting External Devices

composite phono (RCA-type) connection, a good-quality standard cable is recommended. However, some S-video/composite adapters will not work for this application. Contact HP Customer Care for more information.

2. Optional: connect an audio cable from the computer's headphone output jack to the TV audio input. The S-video port doesn't include audio output.

To activate the TV display

HP TV Now automatically adjusts your computer for using a TV. For example, the display timeout is disabled to prevent the screen from turning off, and the resolution is optimized for TV viewing.

- If a One-Touch button is assigned to HP TV Now, press that button. (The five One-Touch buttons are located above the keyboard.)

–or–

- Click Start, All Programs, Hewlett-Packard, Notebook, HP TV Now.

To adjust the HP TV Now options, click Start, All Programs, Hewlett-Packard, Notebook, HP TV Now Options.

To return the display to its normal settings, run HP TV Now again. Normal display settings are also restored if the computer suspends or turns off.

If the image on the TV is bad, the format used for TV output may be incorrect for your TV. In North America, the normal setting is NTSC. In Europe, Asia, and Africa, the normal setting is PAL. To change the TV format, open Control Panel Display, then on the Settings tab click Advanced. On the Displays tab, click the TV button, then set the format on the Format tab.

To play DVD movies on the TV

The movie shows only on the main display. If the movie doesn't appear on the TV, open Display in Control Panel, click the Settings tab, then click Advanced and make the TV a "primary" display.

For more information, see "To play DVD movies" on page 38.

To connect an IEEE 1394 device

If your computer has an IEEE 1394 port (located on the computer's left side), you can use it to connect devices such as audio and video equipment, disk drives, printers, and other computers.

- Attach the device's cable to the IEEE 1394 port on the computer's left side. Windows automatically recognizes the device.

The IEEE 1394 port is a 4-wire port. If you want to connect a device that has a 6-wire plug, you should buy a simple adapter if the device is unpowered, or a hub if the device requires power.

Note

If you have problems making this connection, contact the device manufacturer and the HP Business Support Web site (www.hp.com/go/bizsupport) for the latest version of the driver for the device.

To connect a serial device

The computer includes a standard 9-pin serial port that you can use to connect devices such as external modems and fax modems.

- Connect the device's serial cable to the computer's serial port.
-

To connect an infrared device

If your model has an infrared port—a small, rectangular lens located on the front of the computer—it provides wireless, serial communication between the computer and other infrared devices such as printers or other computers.

By default, the infrared port is not enabled, so you must enable it before you can use it.

1. Click Start, Control Panel, Performance and Maintenance, System.
 2. On the Hardware tab, click Device Manager and expand the infrared devices. Double-click the infrared port and select the option to enable the device.
-

Add-On Devices

Connecting External Devices

Using the infrared port

- Make sure the infrared ports of your computer and the other device lie in as straight a line as possible. The two ports should be no more than 1 meter apart, with no obstructions in between. Noise from nearby equipment can cause transmission errors.
- To check the status of communications, open Wireless Link in Control Panel.

Disabling the infrared port

You should generally disable infrared communication when you aren't using it.

1. Close any applications that are using infrared, and any folders on an infrared link.
2. Click Start, Control Panel, Performance and Maintenance, System.
3. On the Hardware tab, click Device Manager and expand the infrared devices. Double-click the infrared port and select the option to disable the device.

Printing to an infrared printer

- Install your printer and assign it to the computer's infrared port. You can then print from your applications as you would to any other printer.

Transferring files through an infrared connection

You can use your computer's infrared port to transfer files by using Wireless Link. See the Windows online help for instructions on using Wireless Link.

To use a port replicator

A port replicator provides your computer with external connections that you can leave in place whenever you remove the computer from your desk. Instead of disconnecting and reconnecting peripheral devices, you can simply undock and dock the computer.

CAUTION

Use only the HP AC adapter included with your computer (or other approved adapter that meets the power requirements of the computer).

If “75W” is printed below the AC adapter socket on the computer, do not use a 60-watt, 3.16-amp adapter, such as HP F1454A or F1781A, and do not use DC adapter accessories F1455A and F2297A.

Using the wrong AC adapter could damage the computer or adapter and may void your warranty (see "Hewlett-Packard Limited Warranty Statement" on page 130).

You can dock or undock the computer in any power state: on, off, standby, or hibernation. Make sure, however, that the computer is not entering into or resuming from standby or hibernation when you dock or undock, or the computer could lock up.

To dock to the port replicator

1. Plug in the AC adapter, and then connect it to the back of the port replicator. You can also operate the port replicator using power from the computer battery.
2. Remove the rubber cover from the docking connector on the bottom of the computer.
3. Align the computer with the locator posts on the port replicator.

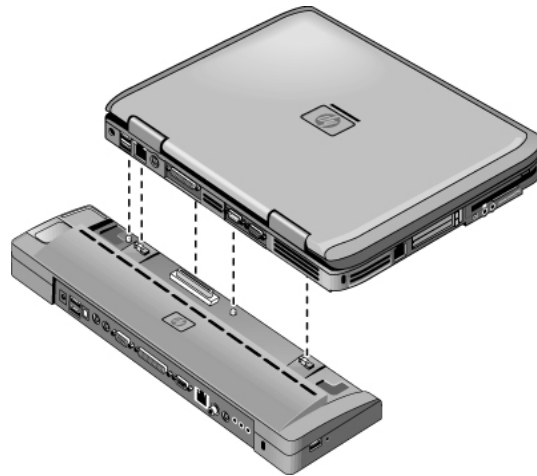

Add-On Devices
Connecting External Devices

4. Press the computer down until both sides click into place.
5. If the computer is off, open the computer and press the power button to turn it on. The lights on the port replicator turn on.

When the computer is docked, you can use the computer's security connector to secure the computer. To secure both the computer and port replicator, install the Kensington lock in the security connector next to the undock button—this locks the undock button.

Note

If a device is connected to an audio port on the computer, any device connected to the corresponding port on the port replicator is ignored.

To undock from the port replicator

1. Press down the undock button on the right side of the port replicator.

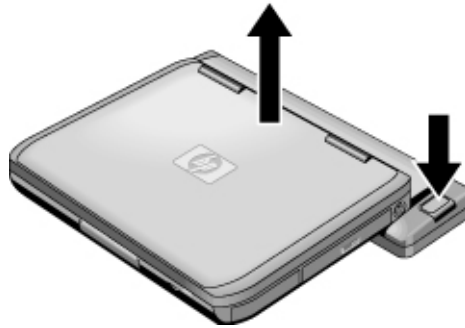

2. Lift the computer out of the port replicator.

Installing Additional RAM

The computer has no memory (RAM) built in but has two slots that hold two RAM modules. At least one slot contains a RAM module installed at the factory. You can use both slots to expand your RAM.

To install a RAM expansion module

Use HP PC2100 DDR-266 or higher RAM only.

You'll need a small Phillips screwdriver for these steps.

CAUTION

Your computer's chips are extremely sensitive to static electricity, and can be permanently damaged by it. Handle the RAM module only by its edges. Before installing the memory module, discharge your body's static electricity by touching the metal shielding around the connectors on the back of the computer.

1. Click Start, Turn Off Computer, Turn Off.
2. **Important:** unplug the AC adapter, if present, and remove the battery.
3. Turn the unit bottom-side up, loosen the screws holding the RAM cover, and remove the cover.
4. Insert the RAM board into the connector at about a 30° angle until it is fully inserted. Then press down at both sides until both latches snap closed.

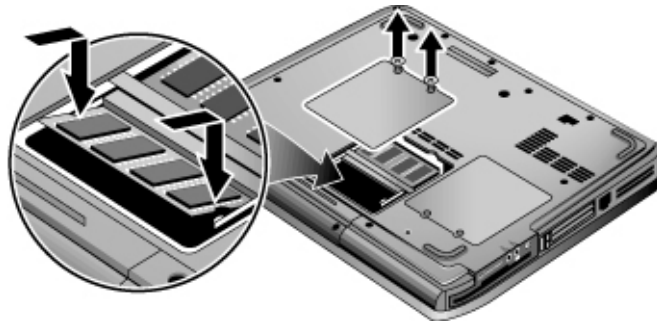

5. Replace the cover.
6. Insert the battery.

To remove a RAM expansion module

You may want to remove a RAM module so you can install a larger one. You'll need a small Phillips screwdriver for these steps.

CAUTION

Your computer's chips are extremely sensitive to static electricity, and can be permanently damaged by it. Handle the RAM module only by its edges. Before installing the memory module, discharge your body's static electricity by touching the metal shielding around the connectors on the back of the computer.

1. Click Start, Turn Off Computer, Turn Off.
2. **Important:** unplug the AC adapter, if present, and remove the battery.
3. Turn the unit bottom-side up, loosen the screws holding the RAM cover, and remove the cover.
4. Release the two latches at the sides of the RAM board, so the free edge of the board pops up.

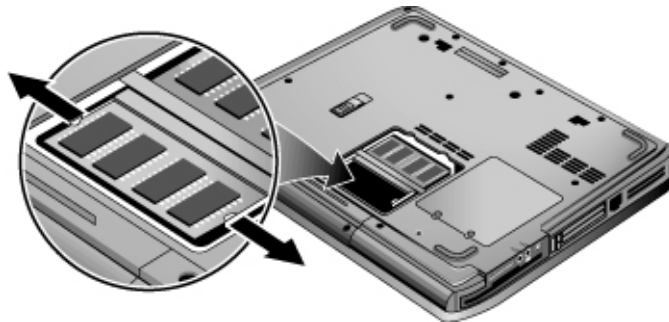

5. Pull the board out of the connector.
6. Replace the cover.
7. Insert the battery.

Replacing the Hard Disk Drive

To replace the hard disk drive

You'll need a small Phillips screwdriver for this procedure.

1. Unplug the AC adapter if you're using one, and remove the battery.
2. Turn the unit bottom side up.
3. Use a pointed tool to remove the plugs from the two screw holes, and then remove the two screws.
4. Gently pull the hard drive out of the computer.

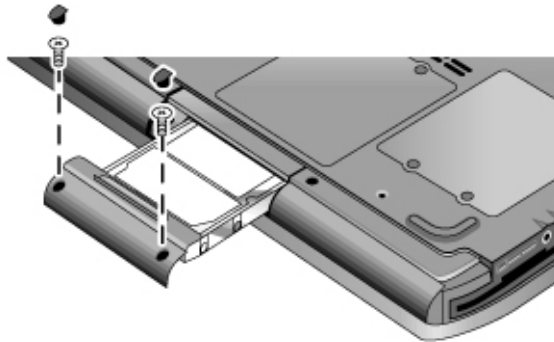

5. Gently slide the new drive into the hard drive compartment. Press firmly to make sure the connector seats properly.
6. Reinstall the hard drive screws and plugs.

Important

If you are installing a new hard disk drive, you should create a Utility partition on the drive before loading any software. See “To recover the factory installation of your hard disk” on page 122.

Add-On Devices
Replacing the Hard Disk Drive

To replace the hard disk drive holder

If you are installing a new hard drive that does not have a holder, you can remove the holder parts from the old hard drive. You'll need a small Phillips screwdriver for this procedure.

1. Remove the four screws from the sides of the holder and drive case, and then slide the drive out of the holder.
2. Notice that the hard drive has a pin connector attachment at one end. Carefully remove this connector from the end of the drive. Work alternately at each end so that the connector slides off evenly without bending the connector pins.

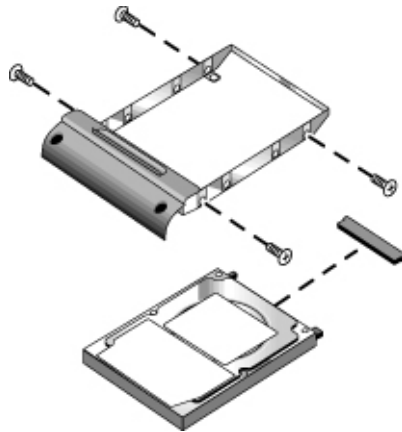

3. Carefully put the pin connector attachment back onto the pins on the end of the new hard drive. Work alternately at each end so that the connector slides on evenly without bending the connector pins.
4. Insert the drive into the holder.
5. Reinstall the screws into the holder and drive case.

To prepare a new hard disk drive

When you install a new hard disk drive, you also need to prepare it to be able to work with your computer.

- If you want to restore the Windows software and operating system that were originally installed on your computer, you can do so using the *Recovery CD* or *DVD* that also came with your computer. See “To recover the factory installation of your hard disk” on page 122.

Troubleshooting and Maintenance

Troubleshooting Your Computer

This section contains solutions to a many types of problems you might have with your computer. Try the solutions one at a time, in the order in which they are presented.

Here are some other sources of information for troubleshooting:

- Open the HP Web-based troubleshooting tool: click Start, All Programs, HP Instant Support. Search or browse the troubleshooting database for the information related to your problem.
- Click Start, Help and Support, Fixing a Problem, and use the Windows troubleshooters.
- See the Microsoft Windows manual shipped with the computer.
- See the HP Notes in the online HP Library for updated information.
- Find technical tips and software updates for the computer at the HP Business Support Web site (www.hp.com/go/bizsupport).
- Test your computer by running the e-Diagtools test program. See “Testing the Hardware” on page 115.
- Contact your dealer or Hewlett-Packard—see “To contact HP for support or service” on page 126. Please have your computer with you when you call.

Audio Problems

If no sound is audible

- If your model has a volume control, press the back end of it several times.
- Click the speaker icon on the taskbar (if present), and make sure that Mute is not checked and the Volume Control slider is not set to the bottom. Or, if your model has an audio mute button, press it so the indicator light goes off.
- When you are operating your computer in MS-DOS mode (for example, when running MS-DOS games), you may find that the sound does not operate properly. Use Windows applications for full use of sound capabilities.

If sound does not record

- Try plugging in an external microphone. Your model may not have a built-in microphone.
- Check the software controls for recording sound: click Start, All Programs, Accessories, Multimedia (or Entertainment), Sound Recorder.
- In Volume Control, click Options, Properties, and make sure the microphone is enabled in the recording controls.
- Test the audio with the e-Diagtools diagnostics. See “Testing the Hardware” on page 115.

If you hear a loud high-pitched whine (feedback) from the speakers

- In the Volume Control, try reducing the Master volume: double-click the speaker icon in the taskbar.
- In Volume Control, click Options, Properties, and select the microphone option for the playback settings. Then in Volume Control, make sure the microphone is muted.
- If your model has a built-in microphone, avoid using it and the built-in speakers at the same time.

CD-ROM and DVD Problems

If you can't boot from a CD or DVD in the CD/DVD drive

- Make sure the CD or DVD is bootable, such as the *Recovery CD* or *DVD*.
- Make sure the CD-ROM/DVD drive is selected as the boot device—see “To change the boot device” on page 27.
- Restart the computer: click Start, Turn Off Computer, Restart.
- Test the DVD drive with the e-Diagtools diagnostics. See “Testing the Hardware” on page 115.

If a DVD plays erratically

- Dirt or smudges can cause a disc to skip. Clean the disc with a soft cloth. If the disc is badly scratched, it will probably have to be replaced.
- If you're playing the DVD on battery power, try changing the power scheme. See the hint under “To play DVD movies” on page 38.

Troubleshooting and Maintenance

Troubleshooting Your Computer

If a DVD movie stops playing in the middle

- The DVD may be double-sided. Open the DVD tray, and read the text near the center hole of the disc. If it says Side A, flip the disc over, close the tray, and press the Play button to continue playing the movie.
- You may have accidentally paused the DVD movie. Press the Play button to resume.

If you get a Region Code error when playing a DVD movie

- DVDs can have regional codes embedded in the disc data. These codes prevent DVD movies from being played outside the region of the world in which they are sold. If you get a Region Code error, you are trying to play a DVD intended for a different region.

If the computer cannot read a CD or DVD

- For a single-sided CD or DVD, make sure the disc is placed in the drive with the label facing up.
- Clean the disc.
- Wait 5 to 10 seconds after closing the tray to give the computer time to recognize the disc.
- Restart the system: remove the disc from the drive, and click Start, Turn Off Computer, Restart.
- If you created the CD on a CD-RW-type drive, try using a different media brand, such as the recommended HP C4403A (CD-R) or C4404A (CD-RW) media. Read and write quality may vary for other media.

If a DVD movie doesn't fill the screen

- Each side of a double-sided DVD has a different format (standard or widescreen). In widescreen format, black bands appear at the top and bottom of the screen. To view the standard format, flip the disc over and play the other side.

If a DVD doesn't play with two displays

- If you're using the Extended Desktop (dual displays), move the player window to the display selected as primary. If you're not using Extended Desktop and both displays are active, press Fn+F5 to switch to one display.

If the computer can't find Wordpad.exe after inserting a CD

- The system is trying to open a .doc file in WordPad, but cannot find the Wordpad.exe program file. Type C:\Program Files\Accessories in the error message box.

Display Problems

If the computer is on, but the screen is blank

- Move the mouse or tap the touch pad. This will wake the display if it is in Display-off mode.
- Press Fn+F5 in case the internal display was disabled. (Do this three times to return to the state you started from.)
- If the computer is cold, allow it to warm up.

If the screen is difficult to read

- Try setting the display resolution to its default setting of 1024×768 or higher, depending on your model: click Start, Control Panel, Appearance and Themes, Display.
- Try adjusting the size of the desktop icons and labels—see “To adjust the display” on page 34.

If an external display does not work

- Check the connections.
- Press Fn+F5 in case the external monitor was disabled. (Do this three times to return to the state you started from.)
- The external monitor may not be detected. In the BIOS Setup utility, try setting Video Display Device to Both in the System Devices menu.
- If you’re using a TV connected to the S-video port, you must activate the TV—see “To use a TV set as a monitor” on page 83.
- Test the display with the e-Diagtools diagnostics. See “Testing the Hardware” on page 115.

If HP Presentation Ready does not switch to your video settings

- If you’re using an external monitor that isn’t a plug-and-play device, open Control Panel Display and set up a monitor that supports the video settings you intend to use for your presentation.

If one or more display pixels look bad

TFT display manufacturing is a highly precise but imperfect technology, and manufacturers cannot produce displays that are cosmetically perfect. Most, if not all, TFT

Troubleshooting and Maintenance

Troubleshooting Your Computer

displays exhibit some level of cosmetic imperfection. These cosmetic imperfections may be visible under varying display conditions, and can appear as bright, dim, or dark spots. *This issue is common across all vendors supplying TFT displays in their products and is not specific to the HP notebook display.*

HP notebook TFT displays meet or exceed all HP standards for cosmetic quality of TFT displays. HP does not warrant that the displays will be free of cosmetic imperfections. *TFT displays can have a small number of cosmetic imperfections and still conform to HP's cosmetic quality specifications, including the following:*

- No more than 6 pixels remain on (always one color, such as white, red, green, or blue dots).
- No more than 6 pixels remain off (always dark).
- No more than a total of 8 pixels stuck on or off.
- No other stuck pixel within 15 mm of a stuck pixel.

Contact HP Customer Care if you have a display quality problem and require a more comprehensive explanation of HP display quality—see “To contact HP for support or service” on page 126. We expect that over time the industry will continue to produce displays with fewer inherent cosmetic imperfections, and we will adjust our HP guidelines as these improvements are implemented.

Hard Disk Drive Problems

If the computer's hard drive doesn't spin

- Make sure the computer has power. If necessary, connect the AC adapter, and make sure it is fully plugged into a power source and into the back of the computer.
- Remove and reinsert the hard drive. See “Replacing the Hard Disk Drive” on page 91.

If the hard disk makes a buzzing or whining noise

- Back up the drive immediately.
- See whether the noise is coming from elsewhere, such as from the fan or a PC Card drive.

If files are corrupted

- Open My Computer, select the disk you want to scan, click File, Properties, and use the Tools tab.

- Run the virus-scanning program. See “To protect against viruses” on page 41.
- Test the hard disk drive with the e-Diagtools diagnostics. See “Testing the Hardware” on page 115.
- If necessary, you can format the hard disk and reinstall the original factory software. See “To recover the factory installation of your hard disk” on page 122.

Heat Problems

Your computer normally gets warm during routine operation.

If the computer gets abnormally hot

- Always set the computer on a flat surface, so that air can flow freely around and underneath it.
- Make sure the air vents on the bottom and sides of the computer are clear.
- Keep in mind that games and other programs that drive CPU usage toward 100% can increase the computer’s temperature.

Infrared Problems

By default, the infrared port is not enabled, so you must enable it before you can use it.

If you have problems with infrared communications

- Make sure the line between the two infrared ports is not blocked, and that the ports face each other as squarely as possible. (The computer’s infrared port is located on the front of the computer.) The ports should be no more than 1 meter apart.
- Check settings in the Device Manager:
 1. Click Start, Control Panel, Performance and Maintenance, System.
 2. On the Hardware tab, click Device Manager and expand the infrared devices. Double-click the infrared port and make sure that the device is enabled.
- Make sure only one application is using the infrared port.
- Remove any PC Cards from the computer. An infrared IRQ conflict is possible if two PC Cards are present at the same time.

Keyboard and Pointing Device Problems

Use these suggestions for built-in or external devices.

If the pointer is difficult to control

- Adjust the pointer controls: click Start, Control Panel, Printers and Other Hardware, Mouse.

If the touch pad doesn't work

- Press the touch pad on-off button so the light turns on.
- Don't touch the touch pad while the computer is rebooting or resuming from Standby mode. If this happens, try the following: press a key on the keyboard to restore normal operation, or suspend and resume operation using the power button.
- If an external mouse is connected, the built-in pointing devices are normally disabled. You can change this setting with the BIOS Setup utility—see “To run the BIOS Setup utility” on page 118.
- Restart the computer: click Start, Turn Off Computer, Restart.

If the touch pad moves the pointer or cursor while you type

- Press the touch pad on-off button to turn off the touch pad while you type.

If a PS/2 scroll mouse doesn't work

- The touch pad must be disabled for the mouse's scroll feature to work. In the BIOS Setup utility, make sure the External Pointing Devices option in the System Devices menu is set to Auto. See “To run the BIOS Setup utility” on page 118.
- Suspend or shut down the computer before you attach the scroll mouse, so that it will be detected properly.

If you want to use the touch pad again, you must suspend or shut down the computer before you detach the scroll mouse.

- Test the keyboard and pointing devices with the e-Diagtools diagnostics. See “Testing the Hardware” on page 115.

If the embedded numeric keypad doesn't work

- To type numbers, make sure Num Lock is on.

- Make sure the embedded Keypad Lock (Fn+F8) is on—or that you press and hold the Fn key to temporarily access the embedded keypad.

If you can't type the euro symbol

- Hold ALT GR when you press the marked key.
- The euro symbol is not on the U.S. English keyboard. Make sure the embedded keypad is active (Fn+F8) and Num Lock is on, and then hold ALT while typing 0128 on the numeric keypad.

If you can't update or reinstall One-Touch software

- Log in as administrator to perform the update or installation.

LAN Problems

If the built-in network adapter doesn't connect to the LAN

- Check all cables and connections. Try connecting at a different network station, if available.
- If the green light next to the LAN port does not light, the LAN cable may not be connected to the network or the network may be down. Try connecting a different computer to the cable.
- Make sure the LAN cable is Category 3, 4, or 5 for 10Base-T operation, or Category 5 for 100Base-TX operation. Maximum cable length is 100 meters (330 feet).
- Click Start, Help and Support (or Help), and use the Networking troubleshooter.
- Open the hardware Device Manager: click Start, Control Panel, Performance and Maintenance, System. If the network interface is disabled, try to enable it. If it has a conflict, try disabling another device.

If you can't browse the Network Neighborhood or My Network Places

- Click Start, Search, Computers or People to look for a computer.

If you can't log in to Netware servers

- If a Netware server is using IPX/SPX protocol, you may need to force your frame type to match the server's frame type. Check with your network administrator.

Troubleshooting and Maintenance

Troubleshooting Your Computer

If a network connection responds slowly

- If your network connection uses a proxy server, try enabling the option for bypassing the proxy server for local addresses. You can do this in Control Panel under your network connection properties.

Memory Problems

If a message says you are out of memory

- Make sure drive C is not running low on free space.
- If you are having memory problems while running MS-DOS programs, use the MS-DOS or Application and Software troubleshooter in Windows Help: click Start, Help and Support (or Help).
- Third-party memory cards have not been tested by HP for use with the computer.
- Test your computer's memory with the e-Diagtools diagnostics. See "Testing the Hardware" on page 115.

If memory doesn't increase after adding RAM

- Make sure your computer is using only PC2100 DDR-266 or higher memory (RAM) modules.

If the computer beeps but doesn't start after adding RAM

- You installed an incompatible type of RAM. Remove the module.

Modem Problems

If the modem seems slow

- Check for excess static or noise on a line reduces the overall transmission speed. If necessary, contact your telephone company about fixing this type of problem.
- If you're dialing internationally, line noise is often a problem that's difficult or impossible to eliminate.
- If you have call-waiting, disable it—your telephone company can provide instructions. It can cause symptoms similar to static.

- Eliminate extra connections in the line. If possible, connect directly to the wall jack.
- Try another telephone line, preferably one normally used for a fax machine or modem.

If the modem doesn't dial or no dial tone is detected

- Check all cables and connections.
- Connect a standard telephone to the phone line and make sure the line is working.
- Make sure someone else isn't using the same phone line.
- Try another telephone line, preferably one normally used for a fax machine or modem.
- If you're in a foreign country, the dial tone may not be recognized by the modem. In Control Panel, open Phone and Modem Options. Try disabling the option that waits for a dial tone.

If the modem dials incorrectly

- Check the telephone number you entered, including any digits required for outside access or long distance.
- In Control Panel, open Phone and Modem Options. Check the dialing options—look for duplicate digits for outside access or long distance.
- Make sure the number you're calling isn't busy.
- If you're in a foreign country, the dial tone may not be recognized by the modem. In Control Panel, open Phone and Modem Options. Try disabling the option that waits for a dial tone.
- If you have call-waiting, disable it—your telephone company can provide instructions.

If the modem dials but doesn't connect

- Make sure you're using an analog telephone line (2, 3, or 4 wires). You must not use a digital line. In a hotel, ask for a data line.
- Try another telephone line, preferably one normally used for a fax machine or modem.
- The modem at the other end may have a problem. Try dialing to a different modem.
- Try disabling error correction and data compression.

Troubleshooting and Maintenance

Troubleshooting Your Computer

If the modem isn't detected

- Check the modem setup. In Control Panel, open Phone and Modem Options. Check the COM port.
- Open the hardware Device Manager: click Start, Control Panel, Performance and Maintenance, System. If the modem is disabled, try to enable it. If it has a conflict, try disabling another device.
- If you're running fax software using fax Class 2, try using Class 1.

If the modem dials but you can't hear it

- If your model has an audio mute light, make sure it is turned off. If it's on, press the audio mute button.
- Check the speaker volume setting.
- In Control Panel, open Phone and Modem Options. Select the modem and click Properties, and then check the volume setting on the General tab.

If the modem connects, but transferred data is bad

- In Control Panel, open Phone and Modem Options. Make sure the parity, speed, word length, and stop bits match on sending and receiving modems.
- Try disabling error correction and data compression.

If the modem causes an ERROR message

- A string of AT commands may contain an incorrect command. If you entered commands as extra settings for the modem in Control Panel or in your communications software, check the commands.

If the modem doesn't fax

- If you're using fax Class 2 in the fax software, try using Class 1.
- Close any other communications programs.
- If you're faxing by printing from an application, make sure you've selected the fax printer.
- Try turning off power management features temporarily.

If excessive line current is detected

- Make sure you're using an analog telephone line (2, 3, or 4 wires). You must not use a digital line. In a hotel, ask for a data line.

If the modem clicks repeatedly but doesn't connect

- Make sure you're using an analog telephone line (2, 3, or 4 wires). You must not use a digital line. In a hotel, ask for a data line.
- Check all cables and connections.

PC Card (PCMCIA) Problems

If the notebook doesn't recognize a PC Card

- Remove and reinsert the PC Card.
- If your model has two PC Card slots and two eject buttons, insert the PC Card in a different slot.
- Press the power button to suspend the computer, and then press it again to resume.
- Restart the computer: click Start, Turn Off Computer, Restart.
- Try the card in another computer to see whether the card functions properly.
- Zoomed Video is not supported.
- If the card requires an IRQ, make sure one is available. Open the hardware Device Manager: click Start, Control Panel, Performance and Maintenance, System.
- Test the PC card with the e-Diagtools diagnostics. See "Testing the Hardware" on page 115.

If an I/O card stops communicating properly

- The card may have been reset if the computer suspended or turned off. Exit any applications, and then remove and reinsert the card.

If a PC card modem is not working

- Disable the internal modem:
 1. Open the hardware Device Manager: click Start, Control Panel, Performance and Maintenance, System.
 2. Double-click Modem to list the current modem devices.
 3. Double-click the internal modem, and then select the option to disable the modem.

Troubleshooting and Maintenance

Troubleshooting Your Computer

If an I/O card stops communicating properly

- Exit and restart the application. The card may have been reset if the computer suspended or turned off.
- Check settings in Control Panel.

Performance Problems

For best performance, your computer should have at least 128 MB of memory (RAM).

If the computer pauses or runs sluggishly

- This may be normal Windows behavior. Background processing can affect response time.
- Certain background operations (such as a virus-scanning program) can affect performance.
- Press CTRL+ALT+DEL and use Task Manager to see if an application is not responding.
- Restart the computer: click Start, Turn Off Computer, Restart.
- Some file browsers respond slowly while processing graphics or waiting for broken network connections to time out.
- If the computer's hard disk drive frequently runs (as indicated by the hard drive light on the front of the computer) while the computer appears to be paused or running slowly, Windows is likely spending excess time writing to its swap file on the computer's hard disk. If this occurs frequently, consider installing additional memory.
- Check the amount of available free disk space. Delete temporary and unneeded files.

If the computer stops responding

- Press CTRL+ALT+DEL and use Task Manager to end the application that is not responding.
- Press the power button for at least 4 seconds to turn off and reset the computer. Then press the power button again to turn the computer back on.
- If nothing happens, insert the tip of a ballpoint pen into the reset button on the bottom of the computer. Then press the power button to turn the computer back on.

Port Replicator Problems

If a connection isn't working

- Check that AC power is connected to the port replicator, that the computer is fully docked, and that the port replicator lights are on.
- Make sure the peripheral device has power connected and is turned on.
- Make sure the device's cable is connected properly.
- The LAN port works only if the computer has a built-in LAN port.
- Try using the corresponding port on the computer while undocked.
- Make sure the computer is fully inserted into the port replicator.

If the operating system hangs when you dock or undock

- Your system may hang if you dock or undock your computer while you are suspending or resuming. Make sure your computer has completely suspended or resumed before you dock or undock it. Also, when you dock or undock, do not undock or dock immediately—wait a few moments while the computer updates its configuration.

Power and Battery Problems

If the computer turns off immediately after it turns on

- Battery power is probably extremely low. Plug in the AC adapter or insert a charged battery.

If the computer keeps beeping

- The computer beeps repeatedly or displays a warning when battery power is low. Save your work, shut down Windows immediately, and insert a charged battery or plug in the AC adapter.

If the battery doesn't charge

- Make sure the AC adapter is fully plugged into the power source and the computer, and that the light on the adapter is on.

Troubleshooting and Maintenance

Troubleshooting Your Computer

- If you're using a power strip, remove the AC adapter from the power strip and plug it directly into a wall outlet.
- Make sure the battery is fully installed and locked in place.
- Make sure you're using only the HP AC adapter included with your computer (or other approved adapter that meets the power requirements of the computer). If "75W" is printed below the AC adapter socket on the computer, do *not* use a 60-watt, 3.16-amp adapter, such as HP F1454 or F1781.
- Move the computer away from any nearby heat source. Unplug the AC adapter and allow the battery to cool down. If the battery gets too hot, it will not charge properly.
- If available, try another battery and AC adapter.

If the computer has a short operating time

- Try conserving power using any of the suggestions listed in "To get the most from your batteries" on page 52.
- If you are running an application that has an automatic save feature (such as MS Word), disable this feature or increase the specified save time to reduce hard disk access.
- If the operating time has gradually become shorter and the battery is more than a year or two old, you may need to replace the battery.
- Heavy modem use can affect battery operating time.
- PC card use can affect battery operating time.
- Test and recondition the battery every 3 months or so using HP Battery Optimizer—see "To get the most from your batteries" on page 52.

If the Time Remaining for the battery is not correct

- The Time Remaining is an estimate, not a precise value, and is based on the rate at which the computer is using power at the moment. This value therefore depends on your current task, and assumes that you will continue using power at the same rate until the battery runs out. So, if you check the Time Remaining while the computer is performing a task requiring a good deal of power (such as reading from a CD or DVD), the value will probably show less time remaining than you really have, since you will probably later switch to tasks that require less power.

If the computer doesn't suspend to Standby mode as expected

- If you have a connection to another computer, the computer won't suspend if the connection is active.
- If the computer is performing an operation, it normally waits for the operation to finish before suspending.

If the computer doesn't automatically hibernate as expected

- Make sure hibernate support is enabled. From Control Panel, open Power Options, and then click the Hibernate tab.

Also, check the Power Schemes tab. Make sure the Hibernate timeouts for both AC power and battery power are not set to Never.

Printing Problems

Hint

You will usually be able to solve most printing problems by using the Print troubleshooter in Windows Help: click Start, Help and Support (or Help).

If a serial or parallel printer doesn't print

- Make sure the printer is on and has paper in it.
- Make sure you are using the correct printer cable or cable adapter, and that the cable is secure at both ends.
- Check for printer errors.

If the left edge of printed output is missing

- Certain applications may not work properly with 600-dpi printers. If you're using such a printer, try selecting a compatible printer driver for a 300-dpi printer. For example, if you were using a 600-dpi HP LaserJet printer, you might try using the HP LaserJet IIIsi driver (300-dpi).

If an infrared printer doesn't print

- Make sure the line between the two infrared ports is not blocked, and that the ports face each other as squarely as possible. (The computer's infrared port is located on the front of the computer.) The ports should be no more than 1 meter apart.
- Make sure the printer is on and has paper in it.
- Check for printer errors.

Troubleshooting and Maintenance

Troubleshooting Your Computer

- Make sure Windows is running; otherwise infrared printing is not available.
- See “Infrared Problems” on page 101.

Serial, Parallel, and USB Problems

If a serial mouse doesn't work

- Make sure you followed the manufacturer's installation instructions completely and have installed the mouse properly. If not, repeat the procedure.
- Make sure the port connection is secure.
- Press the power button to suspend and resume.
- Restart the computer: click Start, Turn Off Computer, Restart.
- Check mouse settings in Control Panel: click Start, Control Panel, Printers and Other Hardware, Mouse.
- Use a mouse that connects to the USB or PS/2 port. If you have a PS/2 keyboard connected, use a PS/2 Y adapter (HP accessory F1469A).
- Check the port settings in Control Panel. Open the hardware Device Manager, and then double-click Ports (COM & LPT).

If a serial modem doesn't work properly

- See “Modem Problems” on page 104.
- Make sure the port connection is secure.
- Use the Modem troubleshooter in Windows Help: click Start, Help and Support (or Help).
- In Control Panel, open Phone and Modem Options, and check the modem settings.
- Disable the internal modem:
 1. Open the hardware Device Manager: click Start, Control Panel, Performance and Maintenance, System.
 2. Double-click Modem to list the current modem devices.
 3. Double-click the internal modem, and then select the option to disable the modem.
- Check the port settings in Control Panel. Open the hardware Device Manager, and then double-click Ports (COM & LPT).

If the serial or parallel port is not working

- Make sure the port connection is secure.
- Check the port settings in Control Panel. Open the hardware Device Manager, and then double-click Ports (COM & LPT).
- Test the ports with the e-Diagtools diagnostics. See “Testing the Hardware” on page 115.

If the USB port is not working

- Contact the vendor of the peripheral device— and the HP Business Support Web site (www.hp.com/go/bizsupport)—for the latest USB drivers.
- Check the port settings in Control Panel. Open the hardware Device Manager, and then double-click Universal Serial Bus Controller.
- Test the USB port with the e-Diagtools diagnostics. See “Testing the Hardware” on page 115.

Startup Problems

If the computer doesn't respond when you turn it on

- Connect the AC adapter.
- Press the power button to try turning on the unit.
- Reset the computer by inserting the tip of a ballpoint pen into the reset button on the bottom of the computer. Then press the power button to turn it on.
- If the computer still doesn't respond, remove the battery and AC adapter, remove any PC cards, and undock the computer if docked. Then plug in the AC adapter again, and reset the computer using the reset button.

If the computer won't boot from battery power

- Make sure the battery is properly inserted and fully charged. Check the battery's charge by removing it and pressing the pad on the side of the battery. The lights show the charge level.
- If available, try another battery.

Troubleshooting and Maintenance

Troubleshooting Your Computer

If the computer won't boot from the floppy disk drive

- Make sure the floppy disk drive is selected as the boot device—see “To change the boot device” on page 27.
- If you're using a USB floppy drive, use the BIOS Setup utility to make sure Legacy USB Support is enabled—see “To run the BIOS Setup utility” on page 118

If the computer stops responding after booting

- Check whether you are connected to a TCP/IP network with no DHCP server. This can cause a long delay at startup because DHCP is enabled. Contact your network administrator to determine the proper TCP/IP configuration.

If the computer takes a long time to resume after being suspended

- The computer can routinely take a minute or more to resume if it has a network card installed. While the operating system is loading drivers and checking hardware and network connections, you will see a blinking cursor on your display. As soon as the hardware has been re-initialized, the Windows desktop will appear.

Wireless Problems

If you have problems with wireless 802.11 communication

- Make sure the wireless indicator light is on.
- If your computer includes Bluetooth capabilities, make sure wireless 802.11 communication is turned on. Click Start, All Programs, Hewlett-Packard, Notebook, HP Wireless Configuration, then click the 802.11 button if it's not turned on.
- Make sure you are using the correct SSID and channel settings: see “To prepare for connections” on page 64.
- Make sure you are in range of an access point (for an infrastructure connection) or other wireless computer (for an AdHoc connection).
- See “LAN Problems” on page 103.

If you have trouble connecting to another computer in the Network Neighborhood or My Network Places

- Wait a few minutes, and then press F5 to refresh the list of computers on the network.
- Click Start, Search, Computers or People to locate the computer.

If you cannot connect to a particular computer on the network

- Make sure the computer is properly connected to the network.
- Make sure your TCP/IP setup is correct for your network: in Control Panel, open Network Connections.

If you can connect, but the network is slow

- Check whether you might be in an area served by more than one wireless LAN. If so, the LANs could be interfering with each other.
- Move closer to the access point (for an infrastructure connection) or other wireless computer (for an AdHoc connection). You could be too far away for high-speed communication.

If your computer cannot detect any Bluetooth devices

- Make sure the wireless indicator light is on.
- Make sure Bluetooth communication is turned on. Click Start, All Programs, Hewlett-Packard, Notebook, HP Wireless Configuration, then click the Bluetooth button if it's not turned on. If no Bluetooth button is shown, your computer does not support Bluetooth communication.
- Make sure the Bluetooth devices are turned on. Some Bluetooth phones must be set for detection and may be detectable by other devices for only a short time.

If your computer cannot detect a certain Bluetooth device

- Make sure the Bluetooth device is turned on. Some Bluetooth phones must be set for detection and may be detectable by other devices for only a short time.
- Refresh the list of Bluetooth devices. Double-click the Bluetooth icon in the taskbar, then click Bluetooth, Search For Devices in the menu bar.

Testing the Hardware

The e-Diagtools hardware diagnostic program included with your computer provides two levels of testing:

- Automated testing using its basic hardware test.
- Advanced testing using individual hardware tests.

The tests are designed to run after the system reboots. This ensures that the computer will be in a predictable state, so the diagnostic program can properly test the hardware components. The tests are non-destructive and are intended to preserve the state of the computer. The computer reboots when you exit the program so drivers can be loaded.

To run the e-Diagtools diagnostic test

1. Click Start, Turn Off Computer, Restart.
2. When the HP logo appears, press F10 to start the diagnostic test.
The first time you run the program, you are prompted to select the language for the program.
3. When the menu appears, press F2 to run e-Diagtools.
4. When the Configuration Description appears, check the list of detected hardware.
5. **Run the basic test.** Press F2 to start the basic hardware test. The results appear when the test is complete.
6. If you intend to exit without running the advanced tests, press F4 to view the Support Ticket. Press F3 to exit e-Diagtools.
7. **Optional: run the advanced tests.** Press F2 to open the advanced test screen.
8. Use the arrow keys and ENTER to select the test you want to run. Tests are listed only for detected hardware.
9. Press F2 to run the selected tests and add the results to the Support Ticket.
10. After each run, press F2 to return to the advanced test screen, or press F4 to view the Support Ticket.
11. **Exit.** Press F3 and then any key to exit and reboot.

12. **Optional: open the Support Ticket.** In Windows, click Start, All Programs, Hewlett-Packard, Notebook, HP e-Diagtools, e-Diagtools for Windows.
13. Click View to display the Support Ticket.
14. To add information about your problem, click Comments, type the information, and then click OK.

To save or print the Support Ticket, click Save As or Print.

To e-mail the Support Ticket to your support agent, click e-Mail. The first time you make an e-mail connection from this program, click Change Settings in the Connect window and enter the settings recommended by your support agent.

e-Diagtools for Windows can also update the version of e-Diagtools on your computer's hard disk. In e-Diagtools for Windows, use the e-Diagtools menu.

If you have trouble running e-Diagtools diagnostics from the hard disk, you can also run it from the *Recovery CD* or *DVD*. Boot from the CD or DVD and select the diagnostics option.

Configuring the Computer

The BIOS Setup utility helps you configure your computer's operation.

To run the BIOS Setup utility

The BIOS (Basic Input and Output System) Setup utility enables you to make changes to the computer's system configuration, and to tailor the operation of your computer to your individual work needs.

The settings made in BIOS Setup generally control the computer's hardware, and so greatly affect how the computer operates.

1. Click Start, Turn Off Computer, Restart.
2. When the HP logo appears, press F2 to enter BIOS Setup.
3. The pointing devices are not active in BIOS Setup, so you will need to use the keyboard to navigate:
 - Press the LEFT and RIGHT arrow keys to move among menus.
 - Press the UP and DOWN arrow keys to move among parameters in a menu.
 - Press + or – to move through values for the current parameter, or press ENTER to change a setting.
4. After you select the options you want, press F10 or use the Exit menu to exit BIOS Setup.
5. If the settings cause a conflict between devices during reboot, the system prompts you to run BIOS Setup, and marks the conflicting settings.

The following tables describe BIOS settings for the BIOS version at publication. If your BIOS is a different version, some settings may differ from those shown.

Main Menu

Setting	Description	Default
BIOS Revision	Shows the current BIOS version.	Detected automatically.
System Time	Sets the time using 24-hour format. Values set take effect immediately.	
System Date	Sets the date using dd/mm/yy format (except English, which uses mm/dd/yy format).	
Language	Sets the language for BIOS Setup.	Detected automatically.
Internal Hard Disk	Sets the hard disk drive type and various parameters.	Detected automatically.
System Memory	Shows the extended memory size.	Detected automatically.
Video Memory	Shows the video memory size allocated from total installed memory (RAM). (Not listed if video memory is separate from installed memory.)	Depends on installed memory.
CPU Serial Number	For a Pentium processor with a serial number, makes the serial number available to software.	Disabled
Serial Number	Displays the serial number as shown on the back of the unit.	Detected automatically.
PC ID	Displays the PC ID String stored in the reserved part of RAM.	
Service ID	Displays an identifier used for repair service.	Detected automatically.
UUID	Displays the value of the 16-byte UUID (Universally Unique ID) as 32 hex characters.	Detected automatically.
MAC Address	Displays the MAC network address of the internal (wired) LAN, if present.	Detected automatically.

Troubleshooting and Maintenance
Configuring the Computer

System Devices Menu

Setting	Description	Default
Video Display Device	Sets whether the built-in display automatically switches to an external display, if one is detected.	Auto
External Pointing Device	Disables the internal pointing devices when an external pointing device is connected.	Auto
Legacy USB Support	Enables BIOS support for USB mouse, keyboard, and floppy disk drive during startup.	Enabled
Wake On LAN from Power Off	Lets the computer be turned on via the LAN port. If this option is enabled, the computer uses increased power while it is shut down.	Disabled

Security Menu

Setting	Description	Default
User Password is	Shows if a user password is set.	Clear
Administrator Password is	Shows if an administrator password is set.	Clear
Set User Password	Press ENTER to set, change, or clear the user password. The password can have no more than 8 characters (0-9, A-Z), and cannot include special or accented characters.	Enter
Set Administrator Password	Press ENTER to set, change, or clear the administrator password, which protects BIOS Setup settings. The password can have no more than 8 characters (0-9, A-Z), and cannot include special or accented characters.	Enter
Require Password on Boot	Sets whether a user password is required when the computer boots. Requires the administrator password for changes.	Disabled
Internal hard disk drive lock	Only if the Boot password option is enabled, encodes the current user password (or administrator password if that is the only password set) on the hard disk drive.	Disabled

Boot Menu

Setting	Description	Default
Hard Disk Removable Device CD-ROM/DVD Built-in LAN	Shows the order of boot devices. Move the entries to change the order. Built-in LAN provides diskless boot from a network server.	1. Hard Disk 2. Removable Device 3. CD-ROM/DVD 4. Built-in LAN

Exit Menu

Setting	Description	Default
Save Changes and Exit	Saves Setup changes, and then exits and reboots.	
Discard Changes and Exit	Discards any Setup changes made since last save, and then exits and reboots. Does not affect password, date, or time changes.	
Get Default Values	Restores default settings, and remains in Setup. Does not affect password, date, or time changes.	

Reinstalling and Updating Software

You can use the *Recovery CD* or *DVD* to recover the original software build for your computer.

The *Recovery CD* or *DVD* also provides Windows drivers specific to your computer to configure a custom system. You can find drivers in these locations:

- On your computer's hard drive under C:\hp\Drivers.
- On the *Recovery CD* or *DVD* under \hp\Drivers.
- On the HP Business Support Web site (www.hp.com/go/bizsupport). This Web site contains the latest updates of software drivers for different operating systems.

To recover the factory installation of your hard disk

You can use the *Recovery CD* or *DVD* to reinstall the original factory software on your computer's hard disk. You can also use the same process to create a Utility partition on a new hard disk. The hidden Utility partition contains the e-Diagtools diagnostic tests.

CAUTION

This procedure formats the computer's hard disk drive and erases all data on the disk. After the hard disk is formatted, you'll need to reinstall your applications.

Do not interrupt the following process or unplug the AC adapter until the process is complete.

1. **Important.** Back up all data from your hard disk. The following steps delete all data from the disk.
2. Plug in the AC adapter.
3. Insert the *Recovery CD* or *DVD* in the CD-ROM or DVD drive. To open the drive when the computer is turned off, insert a straightened paper clip into the hole on the front of the drive.
4. Turn on or restart the computer. If the computer is running, click Start, Turn Off Computer, Restart.
5. When you see the HP logo, press ESC.
6. Select the CD or DVD drive as the boot device.

7. When the *Recovery CD or DVD* dialog box appears, follow the displayed instructions. To perform a standard recovery, press 2, 1, 1. If prompted, accept the recommended partition size. If you install the factory software, the recovery process can take 15 to 45 minutes.

If you want to create the Utility partition without installing the factory software, click Advanced and select the option to not install the operating system.

If your hard disk is partitioned into several drives, you can install the factory software on drive C without affecting other drives. Click Advanced and select to restore only the C partition.

8. When prompted to reboot the computer, press CTRL+ALT+DEL and follow any instructions that appear onscreen.

Windows XP is installed using NTFS format, which cannot be converted to FAT32.

To replace a damaged Recovery CD or DVD

If you lose or damage the *Recovery CD or DVD*, take your computer to a local HP service center to get a replacement CD or DVD. Call the HP Customer Care Center for the address and telephone number of an HP service center near you—see “To contact HP for support or service” on page 126.

To update the BIOS

Hewlett-Packard may provide updates to the computer BIOS to enhance the capabilities of your system. You can use e-Diagtools for Windows to download and install BIOS updates.

CAUTION

Because a BIOS update replaces the previous version, you must follow these instructions exactly, or you risk damaging your computer. The BIOS update process resets the configuration settings in the BIOS Setup utility, except for the PC Identification and BIOS passwords.

1. In Windows, exit any programs that are running.
2. Remove any PC Cards.
3. If the computer is docked, undock it.
4. Connect the AC adapter.

Troubleshooting and Maintenance

Reinstalling and Updating Software

5. Connect any cables or equipment needed to connect to the Internet.
6. Click Start, All Programs, Hewlett-Packard, Notebook, HP e-Diagtools, e-Diagtools for Windows.
7. Click Update, select Download Now and click OK. Follow the instructions that appear. **Once the update process begins, do not interrupt it.**

The first time you make an Internet connection from this program, click Change Settings in the Connect window to define your connection settings.

8. When the process is complete, reset the computer by inserting the tip of a ballpoint pen into the reset button on the bottom of the computer.

BIOS updates are also available from the HP Business Support Web site (www.hp.com/go/bizsupport).

To update Windows drivers

From time to time, HP releases updated versions of the drivers for your computer. These updates are intended to fix any problems that could be encountered in the drivers, and to keep your computer running smoothly. In addition, HP may provide drivers for other versions of Microsoft Windows, in case you decide to install a different version of Windows.

- Download the latest drivers for your computer from www.hp.com/go/bizsupport. Follow the instructions included with the drivers.

HP Support and Service

Getting Assistance for Your Computer

To get help from the Web

HP has several Web sites on the Internet dedicated to providing information to HP notebook computer users. The following sites are especially useful for helping you get support for your computer:

- **HP Business Support Web site.** Get e-mail and telephone support information, technical information, and software updates.
www.hp.com/go/bizsupport
 - **HP Notebook Computer Web site.** Get the latest information about technical support, plus information about warranty and support programs.
www.hp.com/notebooks
-

To contact HP for support or service

HP Customer Care Centers will assist you free of charge during the term of the warranty (you are responsible for the telephone charges).

During the free assistance period, HP will assist with questions about:

- Included applications and operating systems.
- HP-described operation environments and conditions.
- HP accessories, HP upgrades, and basic operation and troubleshooting.

HP will not be able to help with questions about:

- Non-HP hardware, software, operating systems, or usage not intended for or included (by HP) with the product.
 - How to repair the product yourself.
 - Product development, custom installations.
 - Consulting.
-

To contact the HP Customer Care Center by e-mail, visit the HP Business Support Web site (www.hp.com/go/bizsupport) under “Contact HP”.

To call the Customer Care Center, check the HP Business Support Web site (www.hp.com/go/bizsupport) under “Contact HP” for the most complete and current list of phone numbers. If your HP notebook product is not normally sold by HP in the country of use, you must call a Customer Care Center that supports your notebook model. Currently, service and support assistance is provided only in the following countries and regions:

Pavilion models

United States: (208) 323-2551.

United Kingdom: +44 (0)207-512-52-02

France: +33 (0)1-43-62-34-34

Mexico:

 Mexico City: 52-58-9922

 outside Mexico City: 01-800-472-6684

Australia: 61-3-8877-8000

For best service, make sure you have as much of the following available when you call:

- Your computer’s model and serial number.
- Your computer’s operating system.
- Any messages displayed when the problem occurred.
- Were there any changes to the computer, software, related hardware, or accessories before this occurred? Can the problem be re-created?

To receive repair service

If the HP notebook product is not normally sold by HP in the country of use, it must be returned for service to a country in which it is sold and supported.

Note

HP Pavilion notebooks have regional support and service in selected countries. Currently, HP Pavilion notebook PCs are supported only in the country in which they are purchased and marketed. If you are outside the country of purchase, you must cover the cost of shipping your notebook to the appropriate HP authorized repair site.

If you are uncertain about the support available for your notebook, please contact HP Customer Care—see “To contact HP for support or service” on page 126.

If your computer is under warranty. To receive warranty repair service, contact an HP-authorized reseller, or contact the HP Customer Care Center—see “To contact HP for support or service” on page 126. The support technician will help qualify your unit for warranty repair based on the warranty applicable to your unit and original purchase date, and will provide you with repair processes. Warranty service may include the cost of shipping, handling, duties, taxes, freight, or fees to or from the service location.

If your computer is no longer under warranty. Contact an HP-authorized reseller or the HP Customer Care Center (see “To contact HP for support or service” on page 126). The support provider will let you know about repair charges and processes.

Note

You are financially responsible for any repairs to your notebook that are not covered by the HP warranty—see the warranty statement on the next page. This includes any repairs required if you damage your notebook—for example, by spilling liquid onto it, dropping it, or breaking the display.

In addition, most DVD drives let you change the region code only a limited number of times (usually no more than four) to allow you to set the proper region code for your area. When you reach this limit, your last change to the region code will be hard-coded on the DVD drive, and will be permanent. Your HP warranty does not cover the expense of correcting this situation.

To prepare your computer for shipment

See “To receive repair service” above to determine if your computer must be sent in for service. If so, prepare your computer for shipment as follows.

Note

If you have questions about packaging requirements when returning your notebook for repair, contact HP Service and Support—see “To contact HP for support or service” on page 126. If your notebook is not packaged properly, you will be responsible for any damages to it that occur during shipping.

1. **Important.** Back up your hard disk drive. The hard disk may need to be replaced or reformatted while your computer is being repaired.
2. Hewlett-Packard cannot guarantee the return of removable components. Please remove the following prior to sending your computer in for service:
 - PC cards.
 - AC adapter and power cord.
 - Any removable media, such as CDs, DVDs, or floppy disks.
 - Any hardware not involved in the problem and not requested for repair.
3. When sending your notebook to Hewlett-Packard, please use the original product packaging or other substantial packaging to avoid damage to the unit in transit. Make sure that at least three inches of suitable packing material surround the unit.

Your notebook will be returned to you in new packaging.

Note

If the hard disk drive is defective, you will receive a replacement drive that is either unformatted or loaded with software for verification. You should restore the computer’s original software using your *Recovery CD* or *DVD* (see “To recover the factory installation of your hard disk” on page 122) or other recovery method.

Hewlett-Packard Limited Warranty Statement

1. HP warrants to you, the end-user customer, that HP hardware, accessories and supplies will be free from defects in materials and workmanship after the date of purchase, for the period specified in the Warranty Duration table below. If HP receives notice of such defects during the warranty period, HP will, at its option, either repair or replace products which prove to be defective. Replacement products may be either new or equivalent in performance to new.
2. HP warrants to you that HP software will not fail to execute its programming instructions after the date of purchase, for the period specified in the Warranty Duration table below, due to defects in material and workmanship when properly installed and used. If HP receives notice of such defects during the warranty period, HP will replace software which does not execute its programming instructions due to such defects.
3. HP does not warrant that the operation of HP products will be uninterrupted or error free. If HP is unable, within a reasonable time, to repair or replace any product to a condition as warranted, you will be entitled to a refund of the purchase price upon prompt return of the product.
4. HP's limited warranty is valid in any country or locality where HP has a support presence for this product and where HP has marketed this product. The level of warranty service you receive may vary according to local standards. HP will not alter form, fit or function of the product to make it operate in a country for which it was never intended to function for legal or regulatory reasons.
5. Warranty does not apply to defects resulting from (a) improper or inadequate maintenance or calibration, (b) software, interfacing, parts or supplies not supplied by HP, (c) unauthorized modification or misuse, (d) operation outside of the published environmental specifications for the product, or (e) improper site preparation or maintenance.
6. **TO THE EXTENT ALLOWED BY LOCAL LAW, THE ABOVE WARRANTIES ARE EXCLUSIVE AND NO OTHER WARRANTY OR CONDITION, WHETHER WRITTEN OR ORAL, IS EXPRESSED OR IMPLIED AND HP SPECIFICALLY DISCLAIMS ANY IMPLIED WARRANTIES OR CONDITIONS OF MERCHANTABILITY, SATISFACTORY QUALITY, AND FITNESS FOR A PARTICULAR PURPOSE.** Some countries, states or provinces do not allow limitations on the duration of an implied warranty, so the above limitation or exclusion might not apply to you. This warranty gives you specific legal rights and you might also have other rights that vary from country to country, state to state, or province to province.

7. TO THE EXTENT ALLOWED BY LOCAL LAW, THE REMEDIES IN THIS WARRANTY STATEMENT ARE YOUR SOLE AND EXCLUSIVE REMEDIES. EXCEPT AS INDICATED ABOVE, IN NO EVENT WILL HP OR ITS SUPPLIERS BE LIABLE FOR LOSS OF DATA OR FOR DIRECT, SPECIAL, INCIDENTAL, CONSEQUENTIAL (INCLUDING LOST PROFIT OR DATA), OR OTHER DAMAGE, WHETHER BASED IN CONTRACT, TORT, OR OTHERWISE. Some countries, states or provinces do not allow the exclusion or limitation of incidental or consequential damages, so the above limitation or exclusion may not apply to you.

THE WARRANTY TERMS CONTAINED IN THIS STATEMENT, EXCEPT TO THE EXTENT LAWFULLY PERMITTED, DO NOT EXCLUDE, RESTRICT OR MODIFY AND ARE IN ADDITION TO THE MANDATORY STATUTORY RIGHTS APPLICABLE TO THE SALE OF THIS PRODUCT TO YOU.

Product	Duration of Limited Warranty
HP Notebook with "1YR", "3YR", or similar mark on serial-number label	1 year, 3 years, or number of years marked.
HP Notebook with "90D" or similar mark on serial-number label	90 days or number of days marked.
HP Notebook accessories and batteries	1 year
Non-HP accessories	Not warranted by HP. Refer to manufacturer's warranty.
HP Software, Microsoft Software	90 days

Reference Information

Reference Information
Hardware Specifications

Hardware Specifications

Technology Codes

Each HP notebook computer has a two-letter technology code. The technology code is shown on the serial-number label on the bottom of the computer, and it is also included in the BIOS version number.

Because we are constantly improving our products, the specifications shown below are subject to change. For the latest specifications, see the HP Notebook Web site (www.hp.com/notebooks).

Physical Attributes	Size (14-inch display): 328 × 272 × 33 mm (12.9 × 10.7 × 1.3 in). Size (15-inch display): 328 × 272 × 35 mm (12.9 × 10.7 × 1.4 in). Weight: 2.9 kg (6.5 lb) minimum, depending on configuration.
Processor and Bus Architecture	Models with Technology Code KA: AMD Athlon 1600+ to 1900+ (1.3- to 1.6-GHz) or 1.3-GHz Duron processor with PowerNow. Models with Technology Code KB: 1.6- to 2.0-GHz Intel Mobile Pentium 4 processor-M with Intel Speed Step technology. 512-KB L2 cache. 1.2- to 1.3-V core low-power processor with 400-MHz processor system bus.
Video	14.1-inch XGA (1024 × 768), or 15.0-inch XGA (1024 × 768) or SXGA+ (1400 × 1050) active-matrix (TFT) LCD display. Hardware 3D acceleration, hardware DVD acceleration. Models with Technology Code KA: External monitors up to 1600 × 1200 resolution, 16M colors, and at least 85 Hz refresh rate. Refresh rate and clarity may vary depending on monitor, resolution, and color depth. ATI U1 graphics with 16- to 64-MB video RAM shared with system RAM, 4x AGP graphics capability. Dual display capability (depends on operating system support). Models with Technology Code KB: External monitors up to 1600 × 1200 resolution, 16M colors, and at least 85 Hz refresh rate (only 60 Hz at 1400 × 1050). Refresh rate and clarity may vary depending on monitor, resolution, and color depth. ATI Mobility Radeon graphics accelerator with 16- or 32-MB DDR graphics memory, 4x AGP graphics capability. Dual display capability (depends on operating system support).

Power	<p>Rechargeable lithium-ion (14.8 Vdc) battery with LED charge-level gauge. Battery life: up to 3 hours typical (varies with model, usage, and power settings). Fast battery recharge: 2 hours when system is off, 3 hours when system is on. Low-battery warning. Suspend/resume capability. Universal AC adapter: 100–240 Vac (50/60 Hz) input, 19 Vdc output, 75 W.</p>
Mass Storage	<p>20- to 60-GB removable hard drive with Ultra-DMA 100 interface. 1.44-MB floppy drive module (certain models). 24x CD-ROM, or 8x DVD, or CD-RW, or CD-RW/DVD drive (or higher).</p>
RAM	<p>At least 128 MB RAM preinstalled. Models with Technology Code KA: Two slots for PC2100 DDR-266 RAM modules. Up to 1 GB (1024 MB) RAM. Models with Technology Code KB: Two slots for PC2100 DDR-266 RAM modules. Up to 1 GB (1024 MB) RAM using 512-MB modules, future support for 2 GB RAM maximum.</p>
Audio System	<p>Stereo sound via two built-in speakers. 3D-enhanced audio. Volume and mute buttons (certain models). Built-in microphone (certain models). Headphone-out and microphone-in.</p>
Keyboard and Pointing Devices	<p>87/88-key touch-type QWERTY keyboard with 101/102 key emulation. Embedded numeric keypad. 12 function (Fn) keys. 5 user-programmable One-Touch buttons. Touch pad with integrated scroll pad, on-off button and indicator. Left and right click buttons.</p>
LAN (certain models)	<p>Ethernet 10Base-T (10 Mbps) and 100Base-TX (100 Mbps) support. Supports wake-on-LAN, fast IP, DMI, dRMON. MBA (Managed Boot Agent) support for PXE/BINL, NCP/IPX, DHCP.</p>
Modem (certain models)	<p>Software-based modem. Data speed: 56 Kbps (V.92) maximum. Fax speed: 14.4 Kbps, Class 1 and 2. Modulation: V.21, V.22, V.22bis, V.23, V.32, V.32bis, V.34, V.90, V.92, X2, Bell 103, Bell 212A. Synchronous transfer: V.80. Compression: V.42bis, MNP5. Error correction: V.42, MNP2-4. Fax: Group 3 fax, Class 1. V.17, V.27ter, V.29, V.21.</p>

Reference Information
Hardware Specifications

Wireless LAN (certain models)	Radio: IEEE 802.11b, WECA Wi-Fi compliant, direct-sequence spread-spectrum. Operating frequency: 2.4-GHz ISM band, exact frequencies and channels depend on country. Raw data rate: 1, 2, 5.5, or 11 Mbps. Transmitter output: 15 dBm typical (approx. 30 mW), 16 dBm max (approx. 40 mW). Receiver sensitivity: –84 dBm typical. Range: up to 100 m (300 ft) or more, depending on environment and conditions. On-off button and indicator. Mini-PCI interface.
Bluetooth PAN (certain models)	Radio: Bluetooth 1.1 compliant, frequency-hopping spread-spectrum. Operating frequency: 2.4-GHz ISM band. Raw data rate: 721 kbps Transmitter output: 1 dBm typical. Receiver sensitivity: –82 dBm typical. Range: up to 10 m (30 ft), depending on environment and conditions. On-off button and indicator. Internal USB interface.
Input/Output	9-pin, 115,200-bps serial. 25-pin bi-directional ECP/EPP parallel. 15-pin VGA video-out with DDC support. S-video TV out (certain models). PS/2 keyboard/mouse. 4-Mbps IrDA-compliant infrared port (certain models). IEEE-1394 (certain models). Universal serial bus (USB 1.1), two ports.
Expandability	One or two 16-/32-bit PC Card slots, Type II or III, CardBus enabled. Optional port replicator (certain models).
Security Features	User and administrator passwords. System password. PC identification displayed at boot. DMI-accessible electronic serial number. Kensington MicroSaver lock slot.
Environmental Limits	Operating temperature: 5 to 35 °C (41 to 95 °F). Operating humidity: 20 to 90 percent RH (5 to 35 °C). Operating altitude: up to 3000 m (10,000 ft) at 25 °C (77 °F). Storage temperature: –20 to 50 °C (–4 to 122 °F).

Major ICs	<p>Models with Technology Code KA: CPU: AMD Athlon or Duron processor. Core logic: ATI U1 / ALI 1535+ chipset. Display controller: ATI M6 integrated in core logic. Audio/Modem controller: Conexant Smart AMC CX20468-21. CardBus controller: O2Micro 6912. Keyboard/embedded controller: National PC87570. Super I/O: integrated in core logic. IEEE 1394: TI TSB43AB22. LAN: National NS83815. 802.11b wireless LAN: Ambit with Intersil Prism 2.5 chipset. Bluetooth: Ambit with muRata/CSR BlueCore2.</p> <p>Models with Technology Code KB: CPU: Intel Mobile Pentium 4 processor-M. Core logic: ALI 1671 / 1535+ chipset. Display controller: ATI Mobility Radeon M6-C/P. Audio/Modem controller: Conexant Smart AMC CX20468-21. CardBus controller: TI PC1520. Keyboard/embedded controller: National PC87570. Super I/O: integrated in core logic. IEEE 1394: TI TSB43AB22. LAN: National NS83815. 802.11b wireless LAN: Ambit with Intersil Prism 2.5 chipset. Bluetooth: Ambit with muRata/CSR BlueCore2.</p>
------------------	--

Modem Reference Information

If your computer has a modem port, you can customize the operation of the modem using AT commands and S-registers. You can do this from Phone and Modem Options in Control Panel, from most communications software, or by using terminal mode in your software. See “To change your modem settings” on page 60.

Note

You should have a good understanding of modems and how they operate before you change default settings.

This section contains summary information about AT commands, S-registers, and selected result codes for the built-in modem.

Modem Reference (Conexant)

All listed AT commands must be preceded by the characters “AT” (except for the command “A/”). The commands can be entered in upper or lower case. Many commands can be used as queries by entering “?” as the argument.

AT Commands (Conexant)

Command	Function (Conexant)
A	Go off-hook and attempt to answer a call.
A/	Re-execute command (not preceded by AT).
Dn	Dial modifier: 0–9, A–D =DTMF digits; L=redial last number; P=pulse dialing; T=tone dialing; W=wait for dial tone; * (“star”); # (“pound sign”); +=!flash; @=wait for silence; \$ or &=wait for credit card dialing tone; ;=return to command state; ‘=dial pause; ^=toggle calling tone. Parentheses, hyphens, and spaces can be used to format dial string and have no other effect.
E0	Turn off command echo.
E1	Turn on command echo (default).
H0	Initiate hang-up sequence.
H1	If on-hook, go off-hook and enter command mode.
I0	Report product code.
I1	Report LSB of stored checksum.
I2	Report “OK”.
I3	Report identification codes.
I4	Report product description.
I5	Report country code parameter.
I6	Report modem data pump model and internal code revision.
I7	Report modem data pump model and internal code revision.
I8	Report “OK”.
I9	Report country.
Ln	Set speaker volume: 0=off, 1=low (default), 2=medium, 3=high.

Reference Information
Modem Reference Information

Command	Function (Conexant)
Mn	Activate speaker: 0=off, 1=on during handshaking and off when receiving carrier (default), 2=always on, 3=off when dialing and receiving carrier, on when answering.
N0 or N1	Included for compatibility only; returns result code.
On	0=go on-line, 1=go on-line and initiate retrain sequence.
P	Force pulse dialing.
Qn	0=enable result codes to DTE (default), 1=disable.
Sn	Select S-register <i>n</i> as default.
Sn=v	Set default S-register <i>n</i> to value <i>v</i> .
T	Force DTMF dialing.
Vn	Report result codes: 0=short form (terse), 1=long form (verbose) (default).
W0	Report DTE speed (default).
W1	Report line speed, error correction protocol, and DTE speed.
W2	Report DCE speed.
W3	Report DCE speed and error correction protocol.
X0	Report CONNECT result code on connecting. Dial tone and busy detection not reported.
X1	Report CONNECT <text> result code on connecting. Dial tone and busy detection not reported.
X2	Report CONNECT <text> result code on connecting. Dial tone and busy detection not reported.
X3	Report CONNECT <text> result code on connecting. Dial tone not reported, busy signal reported if detected.
X4	Report CONNECT <text> result code on connecting. Dial tone and busy signal reported if detected (default).
Z	Reset to default configuration.
+DR: a	Select error control protocol: NONE=no data compression, V42B=42bis in both directions, ALT=MNP 5 compression.
+DR=n	0=disables extended format "+DR:" intermediate result code, 1=enables.
+DS=a,b,c,d	Controls V.42bis data compression function (<i>b</i> , <i>c</i> , and <i>d</i> are optional): <i>a</i> sets direction(s) of data compression function, seen by DTE: 0=negotiated, no compression; 3=both directions (default). <i>b</i> =0 specifies modem does not disconnect if V.42bis is not negotiated by remote modem as specified by <i>a</i> . <i>c</i> sets maximum number of dictionary entries (2048) that should be negotiated. <i>d</i> sets maximum string length (32 bytes) to be negotiated.
+DS44=a,b,c,d,e,f,g,h,i	Controls V.44 data compression function (<i>b</i> , <i>c</i> , <i>d</i> , <i>e</i> , <i>f</i> , <i>g</i> , <i>h</i> , and <i>i</i> are optional): <i>a</i> sets direction(s) of data compression function, seen by DTE: 0=negotiated, no compression; 1=transmit only; 2=receive only; 3=both directions (default). <i>b</i> specifies whether modem disconnects if V.44 not negotiated remote DCE as specified in <i>a</i> : 0=do not disconnect (default), 1=disconnect. <i>c</i> : 0=stream method (default), 1=packet method, 2=multi=packet method. <i>d</i> (256 to 2048) sets maximum codewords to be negotiated in transmit direction (default=2048). <i>e</i> (256 to 2048) sets maximum codewords to be negotiated in receive direction (default=2048). <i>f</i> (32 to 255) sets maximum string length to be negotiated in transmit direction (default=32). <i>g</i> (32 to 255) sets maximum string length to be negotiated in receive direction (default=32). <i>h</i> (2048 to 4096) sets maximum size of history buffer to be negotiated in transmit direction (default=4096). <i>i</i> (2048 to 4096) sets maximum size of history buffer to be negotiated in receive direction (default=4096).

Reference Information
Modem Reference Information

Command	Function (Conexant)
+ESA= <i>a,b,c,d,e,f,g,h</i>	Controls operation of synchronous access mode: <i>a</i> =0 specifies in transparent sub-mode, modem transmits 8-bit SYN sequence on idle. <i>b</i> =0 specified in framed sub-mode, modem transmits HDLC flags on idle (default and fixed). <i>c</i> =0 specifies in framed sub-mode, modem transmits abort on underrun in middle of frame (default); <i>c</i> =1 specifies in framed sub-mode, modem transmits flag on underrun in middle of frame, notifies DTE. <i>d</i> : not to be commanded. <i>e</i> =0 specifies CRC generation and checking disabled (default and fixed). <i>f</i> =0 specifies NZRI encoding and decoding disabled (default and fixed). <i>g</i> =255 sets the octet value used in character-oriented framing. <i>h</i> : not to be commanded.
+GCAP	Transmit text listing commands that provide additional modem capabilities.
+GCI= <i>n</i>	Set country of installation using 8-bit country code from Annex A of T.35.
+GMI	Report modem manufacturer.
+GMM	Report modem model.
+GMR	Report modem version, revision, or date.
+GOI	Transmit text identifying the device.
+GSN	Report modem model serial number.
+IFC= <i>n,m</i>	Set operation of local flow control between DTE and modem. <i>n</i> =method DTE uses to control data flow from modem: 0=none, 1=XON/XOFF on transmitted data, 2=Circuit 133 (Ready for Receiving) (default). <i>m</i> =method modem uses to control data flow from DTE: 0=none, 1=XON/XOFF on received data, 2=CTS/RTS (default).
+ILRR= <i>n</i>	Report local port rate: 0=disable, 1=enable.
+IPR= <i>n</i>	Set data rate at which the modem accepts commands when connected: 0 (allows operation only at rates automatically detectable by modem), 2400, 4800, 9600, 19200, 38400, 57600, or 115200.
+ITF= <i>a,b,c</i>	Sets transmit flow control thresholds (<i>b</i> and <i>c</i> are optional): <i>a</i> (20 to 7000) sets threshold (octets) above which modem generates flow-off signal in synchronous access mode (default=128). <i>b</i> (10 to 5000) sets threshold (octets) below which modem generates flow-on signal in synchronous access mode (default=64). <i>c</i> =0 (fixed).
+PCW= <i>n</i>	Set modem behavior with call waiting: 1=request modem-on-hold and collect caller ID information, 2=hang up, 3=ignore call waiting.
+PIG= <i>n</i>	0=enable PCM upstream negotiation, 1=disable (default).
+PMH= <i>n</i>	Set modem-on-hold: 0=enabled in V.92 mode (default), 1=disabled.
+PMHF	Initiate flash hook sequence when in modem-on-hold procedure.
+PMHR= <i>n</i>	Request modem to initiate or confirm modem-on-hold (MOH) procedure and timeout: 0=V.92 modem-on-hold request denied or unavailable, 1 to 13 grant MOH with timeout (1=10 sec, 2=20 sec, 3=30 sec, 4=40 sec, 5=1 min, 6=2 min, 7=3 min, 8=4 min, 9=6 min, 10=8 min, 11=12 min, 12=16 min, 13=indefinite).
+PMHT= <i>n</i>	Set whether modem grants modem-on-hold (MOH) request, and MOH timeout: 0=deny V.92 modem-on-hold request (default), 1 to 13=grant MOH with timeout (1=10 sec, 2=20 sec, 3=30 sec, 4=40 sec, 5=1 min, 6=2 min, 7=3 min, 8=4 min, 9=6 min, 10=8 min, 11=12 min, 12=16 min, 13=indefinite).
+PQC= <i>n</i>	Use Short Phase startup procedures: 0=enable V.92 Short Phase 1 and 2 (default), 1=enable Short Phase 1 only, 3=disable.
+PSS= <i>n</i>	0=modems decide whether to use short startup procedures, 2=use full startup procedures on all subsequent connections.
+VCID= <i>n</i>	Set caller ID reporting: 0=disable (default), 1=enable with formatted presentation, 2=enable with unformatted presentation.

Reference Information
Modem Reference Information

Command	Function (Conexant)
+VRID= <i>n</i>	Report caller ID: 0=use formatted presentation, 1=use unformatted presentation.
-QCPC	Use full startup procedures on next connection, then select startup procedure defined by +PQC.
-QCPS= <i>n</i>	0=do not allow modem to save generated quick-connect profile, 1=allow (default)
&C <i>n</i>	Set RLSD: 0=always on, 1=follow carrier state (default).
&D <i>n</i>	0=ignore DTR; 1=upon on-to-off transition, enter online command state and issue OK result code; call remains connected; 2=upon on-to-off transition clear call, discard untransmitted data according to +ETBM.
&E <i>n</i>	0=disable line quality monitor, auto-retrain, and auto-rate renegotiation; 1=enable line quality monitor, auto-retrain, and auto-rate renegotiation (default).
&F0	Restore factory configuration.
&G <i>n</i>	Included for compatibility only; no effect (returns OK).
&K <i>n</i>	Set DTE/DCE flow control: 0=disable, 3=enable RTS/CTS DTE/DCE flow control (default), 4=enable XON/XOFF DTE/DCE flow control, 5 and 6 included for compatibility only (no effect, returns OK).
&M <i>n</i>	Included for compatibility only; no effect (returns result code).
&P <i>n</i>	Set pulse dial (pps) with make/break: 0=10 pps with 39%–61% make/break (default), 1=10 pps with 33%–67% make/break, 2=20 pps with 39%–61% make/break, 3=20 pps with 33%–67% make/break.
&Q5	Select asynchronous operation in error correction mode.
&Q <i>n</i>	(<i>n</i> =0–3, 6) Select asynchronous operation in normal mode (speed buffering).
&T0	Terminate any test in progress.
&T1	Initiate local analog loopback.
&V	Display current configuration and stored profiles.
%TT <i>n</i>	PTT testing of signal level: 00–09=DTMF dial 0–9, 0A=DTMF *, 0B=DTMF #, 0C=DTMF A, 0D=DTMF B, 0E=DTMF C, 0F=DTMF D, 10=V.21 Channel 1mark symbol, 11=V.21 Channel 2mark symbol, 12=V.23 Channel 1mark symbol, 13=V.23 Channel 2mark symbol, 14=Bell103 Channel 1mark symbol, 15=Bell103 Channel 2mark symbol, 20=V22Org, 21=V22Ans, 22=Bell212Org, 23=Bell212Ans, 24=V22BisOrg, 25=V22BisAns, 26=V32@4800, 27=V32@7200, 28=V32@9600, 29=V.32Bis@12000, 2A=V32Bis@14400, 30=Silence, 31=2100Hz MISC, 33=1300Hz MISC, 34=1100Hz MISC, 40=Reserved, 41=V27@2400 FAX, 42=V27@4800 FAX, 43=V29@7200 FAX, 44=V29@9600 FAX, 45=V17@7200LT FAX, 46=V17@7200ST FAX, 47=V17@9600LT FAX, 48=V17@9600ST FAX, 49=V17@12000LT FAX, 4A=V17@12000ST FAX, 4B=V17@14400LT FAX, 4C=V17@14400ST FAX. 5 <i>abc</i> : <i>a</i> =bit rate (0=2400, D=33600), <i>b</i> =V.34 symbol rate (0=2400, 5=3429), <i>c</i> =pre-emphasis filter (0 to A).
\N0	Select normal speed buffered mode.
\N1	Select normal speed buffered mode.
\N2	Select reliable (error-correction) mode.
\N3	Select auto reliable mode.
\N4	Force LAPM mode.
\N5	Force MNP mode.
+MCR	Report carrier.
+MMR	Report transmit and receive rates.
+MR=0	Disable reporting of modulation connection.
+MR=1	Enable reporting of modulation connection (+MCR: and +MRR: are transmitted) (default).
+MR=2	Enable reporting of modulation connection (+MCR: and Receive Rate Only: are transmitted).

Reference Information
Modem Reference Information

Command	Function (Conexant)
+MS= <i>a,b,c,d,e,f</i>	Select modulation (<i>b, c, d, e, and f</i> are optional). <i>a</i> is the carrier (allowable rates in parentheses): B103 (300), B212 (1200 Rx/75 Tx or 75 Rx/1200 Tx), V21 (300), V22 (1200), V22B (1200/2400), V23C (1200), V32 (4800/9600), V32B (4800–14400), V34 (2400–33600), K56 (32000–56000), V90 (28000–56000), V92 (downstream: 28000–56000; upstream: 24000–48000). <i>b</i> is automode: 0=disabled, 1=enabled (default). <i>c</i> is minimum transmit (Tx) rate (bps). <i>d</i> is maximum transmit rate (bps). <i>e</i> is minimum receive (Rx) rate. <i>f</i> is maximum receive rate (bps).
+WS= <i>n</i>	Set PDC mode: 1=disable (default), 20=enable.
ECC Commands	
% <i>Cn</i>	Set data compression: 0=disable, 1=enable V.42 bis and MNP 5, 2=enable V.42 bis and MNP 5, 3=enable V.42 bis and MNP 5 (default).
+EB= <i>a,b,c</i>	Select break handling (<i>b and c</i> are optional): <i>a</i> =0 — break is ignored. <i>b</i> =0 — transmitted V.42 L-SIGNAL will not indicate break signal length. <i>c</i> =0 — break is not delivered to DTE.
+EFCS=0	Select 16-bit FCS specified in V.42.
+ER: <i>a</i>	Select error control protocol: NONE=error control not in use, LAPM=V.42 LAPM protocol, ALT=MNP.
+ER= <i>n</i>	Error control reporting: 0=disable, 1=enable.
+ES= <i>a,b,c</i>	Select error control and synchronous mode (<i>b and c</i> are optional). <i>a</i> is requested mode when modem is originator: 0=initiate call with direct mode, 1=initiate call with normal mode, 2=initiate V.42 without detection phase, 3=initiate V.42 with detection phase (default), 4=initiate MNP, 6=initiate V.80 synchronous access mode when connection is completed. <i>b</i> specifies fallback mode when modem is originator: 0=LAPM, MNP, or normal mode error control optional (default); 1=LAPM, MNP, or direct mode error control optional; 2=LAPM or MNP error control required; 3=LAPM error control required; 4=MNP error control required. <i>c</i> specifies fallback mode when modem is answerer or specifies V.80 synchronous access mode: 1=error control disabled, use normal mode; 2=LAPM, MNP, or normal mode error control optional (default); 3=LAPM, MNP, or direct mode error control optional; 4=LAPM or MNP error control required; 5=LAPM error control required; 6=MNP error control required; 8=initiate V.80 synchronous access mode when connection complete.
+ESR=0	Disable selective repeat option in V.42.
+ETBM= <i>a,b,c</i>	Handle data remaining in modem buffers on call termination (<i>b and c</i> are optional): <i>a</i> =0 — disconnect occurs immediately and buffered transmit data is discarded. <i>b</i> =0 — disconnect occurs immediately and buffered receive data is discarded. <i>c</i> =0 — modem does not attempt to deliver buffered data and discards data.
FAX Class 1	
+FAE= <i>n</i>	Data/fax auto answer: 0=disable (default), 1=enable.
+FAR= <i>n</i>	0=disable adaptive reception (default), 1=enable.
+FCL= <i>n</i>	Set loss-of-carrier delay in units of 100 ms (<i>n</i> =0 to 255).
+FCLASS= <i>n</i>	Set active service class: 0=data mode (default), 1=Fax Class 1, 1.0=Fax Class 1.0 mode, 8=voice mode.
+FIT= <i>n,a</i>	Set DTE inactivity timeout <i>n</i> seconds after which modem goes on-hook (<i>a</i> =0) or DCE goes on hook (<i>a</i> =1).
+FLO= <i>a</i>	Set flow control type: 0=XON/XOFF and RTS/CTS flow control turned off; 1=XON/XOFF flow control in either direction; 2=RTS for flow control of modem by DTE, and CTS for flow control of DTE by modem.

Reference Information
Modem Reference Information

Command	Function (Conexant)
+FMI	Report modem manufacturer.
+FMM	Report modem model.
+FMR	Report modem version, revision, or date.
+FPR= <i>n</i>	Set DTE/modem interface rate in bits/sec: 0=automatic detection (default).
+FRH= <i>n</i>	Receive data with HDLC framing.
+FRM= <i>n</i>	Receive data.
+FRS= <i>n</i>	Receive silence, <i>n</i> ×10 ms.
+FTH= <i>n</i>	Transmit data with HDLC framing.
+FTM= <i>n</i>	Transmit data.
+FTS= <i>n</i>	Stop transmission and wait, <i>n</i> ×10 ms.
Voice Commands	
+FCLASS=8	Select voice mode.
+VDR= <i>a,b</i>	Set report ring cadence and timing of RING event code: <i>a</i> =0 disables ring cadence reporting, <i>a</i> =1 enables. <i>b</i> sets report content: 0=DROF and DRON messages only.
+VDT= <i>a,b</i>	Set report control tone cadence: <i>a</i> =0 disables ring cadence reporting, <i>a</i> =1 enables. <i>b</i> =0 reports CPOF and CPON messages only.
+VDX= <i>a</i>	Select speakerphone half-duplex (<i>a</i> =0) or full duplex (<i>a</i> =1).
+VGM= <i>n</i>	Set microphone gain of speakerphone function (0 to 255).
+VGR= <i>n</i>	Set gain for received voice samples (0 to 255).
+VGS= <i>n</i>	Set speaker gain of speakerphone function (0 to 255).
+VGT= <i>n</i>	Set volume (120 to 135).
+VIP	Initialize all voice parameters to defaults.
+VIT= <i>n</i>	Set initial value for DTE/modem inactivity timer (0 to 255 seconds).
+VLS= <i>n</i>	Select sources/destinations for analog data.
+VNH= <i>n</i>	Set automatic hangups: 0=enable, 1=disable, 2=disable automatic hangups in non-voice modes.
+VPR= <i>n</i>	Set DTE/modem interface rate (0=autobaud).
+VRA= <i>n</i>	Set delay between ringbacks before modem assumes remote station is off hook (0 to 255 x 0.1 sec).
+VRN= <i>n</i>	Set delay between ringbacks before modem assumes remote station is off hook (0 to 60 sec).
+VRX= <i>n</i>	Start voice reception: 0=start without periodic tone production, 1=start with periodic tone production.
+VSD= <i>a,b</i>	Set silence detection sensitivity and required period of silence before modem reports silence at end of voice receive.
+VSM= <i>a,b,c,d</i>	Set voice and silence compression methods, and voice sampling rate.
+VSP= <i>a</i>	Disable (<i>a</i> =0) or enable (<i>a</i> =1) speakerphone.
+VTD= <i>n</i>	Set beep duration (1 to 500 x 0.01 sec).
+VTR	Start voice transmission and reception.
+VTS= <i>string</i>	Send voice tones.
+VTX	Start voice transmission.
AT* Commands	
*B	Display black-listed numbers.
*D	Display delayed numbers.

Reference Information
Modem Reference Information

S-Registers (Conexant)

Register	Function (Conexant)	Range/units	Default
S0	Number of rings to auto-answer.	0-255/rings	0
S1	Ring counter.	0-255/rings	0
S2	Escape character.	0-255/ASCII	43
S3	Line termination character.	0-127/ASCII	13
S4	Response formatting character.	0-127/ASCII	10 (line feed)
S5	Command line editing character.	0-32/ASCII	8 (backspace)
S6	Wait time for dial tone.	2-255/sec	2
S7	Wait time for carrier.	1-255/sec	50
S8	Pause time for dial delay modifier.	0-255/sec	2
S10	Carrier loss disconnect time.	1-255/.1 sec	14 (1.4 sec)
S11	DTMF tone duration.	50-255/.001 sec	95 (95 msec)
S12	Escape prompt delay.	0-255/.02 sec	50 (1 sec)
S18	Test timer.	0-255/sec	0
S29	Flash dial modifier time.	0-255/10 msec	70 (700 msec)
S30	Disconnect inactivity timer.	0-255/10 sec	0
S46	Data compression control.	136 (error correction w/o compression) or 138 (error correction & compression)	138
S95	Extended result code messages control.		0

Selected Result Codes (Conexant)

Code	Meaning
0	OK
1	CONNECT
2	RING
3	NO CARRIER
4	ERROR
5	CONNECT 1200
6	NO DIAL TONE
7	BUSY
8	NO ANSWER
24	DELAYED
32	BLACKLISTED
33	FAX
35	DATA
83	LINE IN USE

Safety Information

Power Cords

The power cord supplied with the computer's AC adapter should match the plug and voltage requirements for your local area. Regulatory approval for the AC adapter has been obtained using the power cord for the local area. However, if you travel to a different area or need to connect to a different outlet or voltage, you should use one of the power cords listed below. To purchase a power cord (including one for an area not listed below) or a replacement AC adapter, contact your local Hewlett-Packard dealer or Sales and Service office. For any power cord with a fused plug, if you have to replace the fuse, be sure to install an approved fuse.

Country or Region	Rated Voltage and Current	HP Part Number
Canada Mexico Philippines Taiwan United States	125 Vac (3 A)	8120-6313
East and West Europe Egypt Saudi Arabia	250 Vac (2.5 A)	8120-6314
Hong Kong Singapore United Kingdom	250 Vac (2.5 A)	8120-8699
Australia New Zealand	250 Vac (2.5 A)	8120-6312
Japan	125 Vac (3 A)	8120-6316
India	250 Vac (2.5 A)	8121-0702
South Africa	250 Vac (2.5 A)	8120-6317
Argentina	250 Vac (2.5 A)	8120-8367
Chile	250 Vac (2.5 A)	8120-8452
China	250 Vac (2.5 A)	8120-8373
South Korea	250 Vac (2.5 A)	8120-8441

Reference Information
Safety Information

Ergonomics

WARNING

Improper use of keyboards and other input devices has been associated with ergonomic injury. For information about reducing your risk, see Working in Comfort in the online HP Library or visit our ergonomics Web site, www.hp.com/ergo.

Battery Safety

Note

The following batteries are compatible only with HP notebook computers:

- HP: F4809 and F4812
- Sanyo: 4UR18650F-2-QC-KT
- Simplo: 916-2150
- Panasonic: CGR-B/862AE

- To avoid risk of fire, burns, or damage to your battery pack, do not allow a metal object to touch the battery contacts.
- Do not disassemble the battery. There are no serviceable parts inside. Do not dispose of the battery pack in fire or water.
- Handle a damaged or leaking battery with extreme care. If you come in contact with the electrolyte, wash the exposed area with soap and water. If it contacts the eye, flush the eye with water for 15 minutes and seek medical attention.
- Do not expose the battery pack to storage temperatures above 60 °C (140 °F).
- When discarding a battery pack, contact your local waste disposal provider regarding local restrictions on the disposal or recycling of batteries.
- To obtain a replacement battery, contact your local dealer or HP sales office.
- Do not charge the battery pack if the ambient temperature exceeds 45 °C (113 °F).
- Replace only with the same or equivalent type battery pack recommended by the manufacturer.
- This product contains a lithium-ion or nickel-metal-hydrate battery, and may require special handling at end-of-life.



Laser Safety

The CD-ROM and DVD drives used with the computer are certified as a Class 1 laser devices according to the U.S. Department of Health and Human Services (DHHS) Radiation Performance Standard and International Standards IEC 825 / IEC 825-1 (EN60825 / EN60825-1). These devices are not considered harmful, but the following precautions are recommended:

- Ensure proper use by reading and following the instructions carefully.
- If the unit requires service, contact an authorized HP service center—see “To contact HP for support or service” on page 126.
- Do not attempt to make any adjustment of the unit.
- Avoid direct exposure to the laser beam—do not open the unit.

CLASS 1 LASER PRODUCT LASER KLASSE 1

LED Safety

The infrared port located on the front of certain models is classified as a Class 1 LED (light-emitting diode) device according to International Standard IEC 825-1 (EN60825-1). This device is not considered harmful, but the following precautions are recommended:

- If the unit requires service, contact an authorized HP service center—see “To contact HP for support or service” on page 126.
- Do not attempt to make any adjustment of the unit.
- Avoid direct eye exposure to the infrared LED beam. Be aware that the beam is invisible light and cannot be seen.
- Do not attempt to view the infrared LED beam with any type of optical device.

CLASS 1 LED PRODUCT LEDSCHÜTZKLASSE 1 PRODUKT
--

Mercury Safety

This product contains mercury in the fluorescent lamp of the liquid-crystal display, and may require special handling at end-of-life.

Exposure to Radio Frequency Radiation

The radiated output power of the IEEE 802.11 and Bluetooth internal wireless radio is far below the FCC radio frequency exposure limits. Nevertheless, the wireless radio shall be used in such a manner that the potential for human contact during normal operation is minimized.

The internal wireless radio operates within guidelines found in radio frequency safety standards and recommendations, which reflect the consensus of the scientific community. HP therefore believes the internal wireless radio is safe for use by consumers. The level of energy emitted is far less than the electromagnetic energy emitted by wireless devices such as mobile phones. However, the use of wireless radios may be restricted in some situations or environments, such as aboard airplanes. If you are unsure of restrictions, you are encouraged to ask for authorization before turning on the wireless radio.

Regulatory Information

This section presents information that shows how your computer complies with regulations in certain regions. Any modifications to your computer not expressly approved by Hewlett-Packard could void the authority to operate the computer in these regions.

U.S.A.

This computer has been tested and found to comply with the limits for a Class B digital device, pursuant to Part 15 of the FCC Rules. These limits are designed to provide reasonable protection against harmful interference in a residential installation.

This computer generates, uses, and can radiate radio frequency energy. If not installed and used in accordance with the instructions, it may cause harmful interference to radio communications. However, there is no guarantee that interference will not occur in a particular installation. If this computer does cause harmful interference to radio or television reception (which can be determined by removing the unit's batteries and AC adapter), try the following:

- Reorienting or relocating the receiving antenna.
- Relocating the computer with respect to the receiver.
- Connecting the computer's AC adapter to another power outlet.

Connections to Peripheral Devices

To maintain compliance with FCC Rules and Regulations, use properly shielded cables with this device.

For more information, consult your dealer, an experienced radio/television technician, or the following booklet, prepared by the Federal Communications Commission: *How to Identify and Resolve Radio-TV Interference Problems*. This booklet is available from the U.S. Government Printing Office, Washington, DC 20402, Stock Number 004-000-00345-4. At the first printing of this manual, the telephone number was (202) 512-1800.

Reference Information
Regulatory Information

Declaration of Conformity (U.S.A.)

Responsible Party: Hewlett-Packard Company
Manager of Corporate Product Regulations
3000 Hanover Street
Palo Alto, CA 94304
+1 (650) 857-1501

declares that the product(s)

Trade name: Hewlett-Packard Company

Product name: HP Pavilion ZE4... and XT... series

Complies with Part 15 of the FCC Rules. Operation is subject to the following two conditions:

1. This device may not cause harmful interference, and
2. This device must accept any interference received, including interference that may cause undesired operation.

Canada

This digital apparatus does not exceed the Class B limits for radio noise emissions from digital apparatus as set out in the radio interference regulations of the Canadian Department of Communications. The internal wireless radio complies with RSS 210 of Industry Canada.

Le présent appareil numérique n'émet pas de bruits radioélectriques dépassant les limites applicables aux appareils numériques de Classe B prescrites dans le règlement sur le brouillage radioélectrique édicté par le Ministère des Communications du Canada. Le composant RF interne est conforme à la norme CNR-210 d'Industrie Canada. L'utilisation de ce dispositif est autorisée seulement aux conditions suivantes : (1) il ne doit pas produire de brouillage et (2) l'utilisateur du dispositif doit être prêt à accepter tout brouillage radioélectrique reçu, même si ce brouillage est susceptible de compromettre le fonctionnement du dispositif.

European Union

The equipment has been approved in accordance with Council Decision 98/482/EC for pan-European single terminal connection to the public switched telephone network (PSTN) and to a radio-frequency wireless network. However, due to differences between the individual PSTN's provided in different countries, the approval does not, of itself, give an unconditional assurance of successful operation on every PSTN network termination point.

In event of problems, you should contact your equipment supplier in the first instance.

This equipment has been designed to work in all of the countries of the European Economic Area (Public Switched Telephone Networks). Network compatibility is dependent on internal software settings. Contact your equipment supplier if it is necessary to use the equipment on a different telephone network. For further product support, contact Hewlett-Packard—see “To contact HP for support or service” on page 126.

Belgium: For outdoor usage only channels 10 (2457 MHz) through 13 (2472 MHz) are allowed. For private usage outside buildings across public grounds over less than 300m, no special registration with IBPT/BIPT is required. Registration to IBPT/BIPT is required for private usage outside buildings across public grounds over more than 300m. An IBPT/BIPT license is required for public usage outside building. For registration and license please contact IBPT/BIPT.

France: Restricted frequency band: only channels 10 through 13 (2457 MHz through 2472 MHz respectively) may be used in France. License required for every installation, indoor and outdoor installations. Please contact ART for the procedure to follow. Use with outdoor installations not allowed.

Germany: License required for outdoor installations. Check with reseller for procedure to follow.

Netherlands: License required for outdoor installations. Check with reseller for procedure to follow.

Italy: Indoor or outdoor use in a public area requires a user license.

Reference Information

Regulatory Information

Die Geräte wurden gemäß Ratsentscheidung 98/482/EC für den Anschluss an eine einzelne Telefonbuchse im europäischen Raum (Public Switched Telephone Network) und drahtlose Funknetzwerke zertifiziert. In Anbetracht der Unterschiede zwischen den einzelnen Telefonnetzen bietet die Zertifizierung für sich genommen keine absolute Sicherheit, dass die Geräte bei Anschluss an jeder beliebigen Telefonbuchse funktionieren.

Sollten Probleme auftreten, wenden Sie sich zunächst an den Gerätehersteller. Diese Geräte wurden zum Betrieb in allen Ländern der europäischen Wirtschaftsgemeinschaft entwickelt (Public Switched Telephone Networks). Die Kompatibilität zum Netz ist von internen Software-Einstellungen abhängig. Wenden Sie sich an den Gerätehersteller, wenn Sie die Geräte in einem anderen Telefonnetz einsetzen müssen. Weitere Informationen zur Unterstützung für das Produkt erhalten Sie bei Hewlett-Packard.

Cet équipement a été reconnu conforme aux décisions du Conseil 98/482/EC relatives à la connexion pan-européenne de terminal simple au réseau téléphonique public commuté (RTPC) et à un réseau sans fil RF. Cependant, des différences existant entre les RTPC nationaux présents dans les différents pays, cette homologation en elle-même ne garantit pas la réussite de toutes les opérations sur tous les points de terminaison du réseau téléphonique public commuté.

En cas de problème, prenez contact avec le fournisseur auprès duquel vous vous êtes procuré votre équipement.

Cet équipement a été conçu pour fonctionner dans tous les pays membres de la zone d'échange européenne (Réseaux Téléphoniques Public Commutés).

La compatibilité entre réseaux dépend des paramètres internes du logiciel.

Prenez contact avec le fournisseur auprès duquel vous vous êtes procuré votre équipement pour savoir s'il est préférable d'utiliser ce dernier sur un autre réseau téléphonique. Si vous souhaitez obtenir de l'aide, prenez contact avec Hewlett-Packard.

Questa apparecchiatura è stata approvata in conformità alla Decisione del Consiglio 98/482/EC che regolamenta, in seno all'Unione Europea, la connessione di singoli terminali alla rete telefonica pubblica commutata (PSTN) e alla rete wireless in radio frequenza. Tuttavia, a causa delle differenze esistenti tra i singoli servizi PSTN forniti nei diversi paesi, l'approvazione in sé stessa non rappresenta una garanzia assoluta di funzionamento su ogni singolo punto di terminazione della rete PSTN.

In caso di problemi, per prima cosa rivolgersi al fornitore dell'apparecchiatura.

Questa apparecchiatura è stata progettata per funzionare in tutti i paesi dell'Area Economica Europea (reti telefoniche pubbliche commutate). La compatibilità della rete dipende dalle impostazioni interne del software. Rivolgersi al fornitore dell'apparecchiatura qualora sia necessario utilizzare quest'ultima su una rete telefonica diversa. Per ulteriore assistenza sul prodotto, contattare Hewlett-Packard.

Japan

この装置は、情報処理装置等電波障害自主規制協議会（VCCI）の基準に基づくクラスB情報技術装置です。この装置は、家庭環境で使用することを目的としていますが、この装置がラジオやテレビジョン受信機に近接して使用されると受信障害を引き起こすことがあります。

取り扱い説明書に従って正しい取り扱いをして下さい。

Japan Telecommunications Approval

Name of Equipment: AMC20493-001-KT1, AMC20493-001-KT3,
AMC20493-001-KT5, AMC20493-001

機器に内蔵の無線LANをお使いのお客様へ。

この機器の使用周波数帯では、電子レンジ等の産業・科学・医療用機器のほか工場の製造ライン等で使用されている移動体識別用の構内無線局（免許を要する無線局）及び特定小電力無線局（免許を要しない無線局）が運用されています。

- 1 この機器を使用する前に、近くで移動体識別用の構内無線局及び特定小電力無線局が運用されていないことを確認して下さい。
- 2 万一、この機器から移動体識別用の構内無線局に対して電波干渉の事例が発生した場合には、速やかに使用周波数を変更するか又は電波の発射を停止した上、下記連絡先にご連絡頂き、混信回避のための処置等（例えば、パーティションの設置など）についてご相談して下さい。
- 3 その他、この機器から移動体識別用の特定小電力無線局に対して電波干渉の事例が発生した場合など何かお困りのことが起きたときは、次の連絡先へお問い合わせ下さい。

連絡先： 03-5344-7181

TELEC approval number: D02-0005JP
Name of Equipment: T60H424

2.4DS1

Reference Information
Regulatory Information

Russia

Продукт сертифицирован в системе ГОСТ Р
Модем сертифицирован в системе ЭЛЕКТРОСВ



International

Products sold internationally by Hewlett-Packard and its authorized dealers meet the specifications listed on the following page.

Note

For regulatory identification purposes, your product is assigned a Regulatory Model Number. The Regulatory Model Number for your product is listed in the declaration below. This regulatory number is different from the marketing name and product number.

Declaration of Conformity (according to ISO/IEC Guide 22 and EN 45014)

Manufacturer's Name: Hewlett-Packard Company, Mobile Computing Division
Manufacturer's Address: 19310 Pruneridge Ave., Cupertino, CA 95014, U.S.A.

declares that the following product

Product Name: Omnibook XE4... series, Pavilion ZE4... and ZE5... series, Pavilion XT... series
Regulatory Model Numbers: CRVSA-02T1-60, CRVSA-02T1-75, CRVSA-02T1-90
Product Options: Includes all options for analog modems (Conexant) and 802.11b and Bluetooth RF devices (Ambit)

conforms to the following product specifications

Safety: IEC 60950: 1991 +A1,A2,A3,A4 / EN 60950: 1992 +A1,A2,A3,A4,A11
IEC 60825-1: 1993 +A1 / EN 60825-1: 1994 +A11 Class 1 LED
GB4943-1995

EMC: EN 55022: 1994 +A1: 1995 +A2: 1997, Class B [1]
CISPR 24: 1997 / EN 55024: 1998
IEC 61000-3-2: 1995 / EN 61000-3-2:1995 +A1: 1998 +A2: 1998
IEC 61000-3-3: 1994 / EN 61000-3-3:1995
GB9254-1998
FCC Title 47 CFR, Part 15 Class B/ANSI C63.4: 1992
AS/NZS 3548: 1995 Rules and Regulations of Class B

Telecom: TBR 21: 1998, EG 201 121: 1998

Radio: EN 301 489-17: 2000 Specific conditions for wideband data HYPERLAN equipment
Equipment Class 2 EN 300 328-2: 2000 Technical requirements for Radio equipment
Notified Body Number: 0682
Notified Body Address: CETECOM ICT Services GmbH, Untertuerkheimer Str. 6-10, D-66117 Saarbruecken

Supplementary Information: The product herewith complies with the requirements of the R&TTE Directive 1999/5/EC and carries the CE marking accordingly.

[1] The product was tested in a typical configuration with Hewlett-Packard Personal Computer peripherals.

This device complies with Part 15 of the FCC Rules. Operation is subject to the following two conditions:
(1) this device may not cause harmful interference, and (2) this device must accept any interference received, including interference that may cause undesired operation.

The HP F1454, F1781, F4600, F4814, F4813, F5104, 5950-4334, and 5950-4359 ac/dc adapters used with this product are designed to operate on all power systems, other than IT power systems.

Corvallis, OR, June 21, 2002



Jerry Erickson, R&D Product Execution Manager

European Contact for regulatory topics only: Hewlett Packard GmbH, HQ-TRE, Herrenberger Strasse 140, 71034 Boeblingen, Germany. Fax: +49 7031 143143.
USA Contact: Hewlett Packard Co., Corporate Product Regulations Manager, 3000 Hanover Street, Palo Alto, CA 94304, U.S.A. Phone: +1 (650) 857-1501.

Index

A

- AC adapter
 - compatibility, 21, 87
 - connecting, 21
- AC adapter jack
 - location, 15
- accessories
 - buying, 12
- adding RAM, 89
- AdHoc wireless network
 - setting up, 65
- adjusting
 - brightness, 30, 34
 - display colors, 34
 - screen area, 34
 - volume, 30
- airplanes
 - wireless communication in, 66, 68
- ALT GR key, 33
- antistatic precautions, 89, 90
- Applications key, 32
- AT commands, 60, 138
- audio
 - adjusting volume, 35, 96
 - connecting devices, 81
 - muting, 35
 - troubleshooting, 96
 - volume, 30
- audio jacks, 15
- audio mute button, 15

B

- battery
 - best use of, 53
 - checking status, 51
 - conditioning, 53
 - extending life of, 53
 - installing, 19
 - location, 14
 - low power warning, 52
 - operating time, 52, 110
 - release latch, 16
 - safety, 146
 - saving power, 52
 - status lights, 51
 - testing, 53
 - troubleshooting, 109

- Battery Optimizer, 53
- BIOS
 - password, 39
 - updating, 123
- BIOS Setup utility
 - Boot menu, 121
 - Exit menu, 121
 - external display settings, 120
 - Main menu, 119
 - Security menu, 120
 - using, 39, 118
- black list (modem), 58
- blackout periods
 - modem, 58
- Bluetooth
 - business cards, 70, 71
 - configuring, 70
 - dial-up network connections, 73
 - sending files, 71
 - serial connections, 72
 - troubleshooting, 114
 - tuning on, 68
 - turning off, 69
 - wireless, 68
- boot device order, 27, 121
- Boot menu (BIOS), 121
- brightness
 - adjusting, 30, 34
- business cards, 70, 71

C

- Caps Lock, 14, 18
- Cardbus cards, 76
- cards (PCMCIA), 76
- CD-ROM drive
 - creating or copying CDs, 38
 - inserting CD, 37
 - location, 14
 - removing CD, 37
- CDs
 - creating or copying, 38
 - recommended media, 38
- cleaning the computer, 46
- clicking items, 29
- COM1 port, 15
- computer
 - caring for, 44
 - changing BIOS settings, 39, 118
 - cleaning, 46

- opening/closing, 14
 - protecting, 44, 101
 - reinstalling Windows, 122
 - resetting, 27
 - testing, 116
 - timeouts, 49
 - turning on, 23
- configuring
 - BIOS settings, 39, 118
 - modem, 60
 - touch pad, 29
 - connecting
 - audio devices, 81
 - external monitor, 82
 - IEEE 1394 devices, 85
 - infrared device, 85
 - LAN, 63
 - modem, 57
 - parallel device, 80
 - port replicator, 87
 - serial device, 85
 - to Internet, 24, 58
 - USB device, 80
 - wireless network, 64
 - cursor (pointer), 29
 - Customer Care
 - getting support, 126
 - Web site, 13
- ## D
- data
 - protecting, 45
 - DDR-266 RAM, 89, 104
 - default BIOS settings, 119
 - Desktop Zoom, 34
 - devices
 - boot order, 121
 - external display, 33
 - infrared, 85
 - parallel, 80
 - ports for, 78
 - serial, 85
 - temporary boot order, 27
 - USB, 80
 - diagnostics, 116
 - dial-in network connections, 59
 - dial-up network connections
 - Bluetooth, 73
 - display

- BIOS settings, 120
- brightness, 30, 34, 45, 52
- dual display, 83
- dual monitor, 83
- extending life, 45
- external, 82
- port, 15
- power, 53
- quality, 100
- secondary, 83
- settings, 34
- switching to external, 33
- troubleshooting, 99
- display colors
 - adjusting, 34
- docking
 - port replicator, 87
- docking port, 16
- dragging items, 29
- drive lock, 41
- drivers
 - downloading, 124
- drives
 - hard drive holder, 92
 - hard drive lock, 41
 - replacing hard disk, 91, 93
- DVD drive
 - location, 14
 - playing movies, 38
 - setting region code, 38
 - troubleshooting, 97

E

- e-Diagtools for Windows, 117
- e-mail
 - HP Customer Care, 127
 - sending and receiving, 61
- encryption, 64
- ergonomics, 19
- euro symbol, 103
- Exit menu (BIOS), 121
- extended memory, 119
- external monitor port
 - location, 15
- external mouse
 - configuring, 29

F

- F10 (diagnostics), 116
- FAT32 format, 123
- Fax Console, 62
- faxes, 62
- files
 - protecting, 41

- recovering, 122
- floppy disk drive
 - location, 15
- Fn key
 - + Back Space (mute), 30
 - + F1 (decrease brightness), 30, 34
 - + F12 (hibernate), 30
 - + F2 (increase brightness), 30, 34
 - + F5 (display select), 30, 82
 - + F8 (keypad), 30, 33
 - + NumLock (scroll lock), 30
 - + Page Down (decrease audio), 30
 - + Page Up (increase audio), 30
 - temporary keypad, 33

H

- hard disk drive
 - caring for, 45
 - FAT32 format, 123
 - Hibernate partition, 91
 - holder, 92
 - location, 16
 - locking, 41
 - NTFS format, 123
 - preparing for use, 93
 - protecting, 44
 - replacing, 91
 - troubleshooting, 100
- hardware specifications, 134
- Hewlett-Packard support, 126
- Hibernate mode
 - definition, 26
 - entering, 50
 - status lights, 17
- Hibernate partition, 91
- hot computer, 101
- hot keys, 30
- HP Battery Optimizer, 53
- HP Business Support
 - Web site, 13
- HP Customer Care
 - contact by e-mail, 127
 - getting support, 126
- HP Desktop Zoom, 34
- HP Instant Support, 96
- HP Library, 13
- HP Notes, 13
- HP Quick Lock, 39
- HP TV Now, 84

I

- IEEE 1394 port
 - connecting devices, 85

- location, 15
- infrared communication
 - transferring files, 86
 - troubleshooting, 101
- infrared port
 - location, 14
 - making connections, 85
 - printing, 86
 - safety, 147
 - troubleshooting, 101
- inserting
 - CD, 37
 - DVD, 37
 - PC Card, 76
- installing
 - hard disk drive, 91
 - hard drive holder, 92
 - RAM, 89
- installing original software, 122
- Internet
 - connect icon, 58
 - connecting to, 24, 58
 - disconnecting, 59
- Internet Explorer, 58
- Internet Service Provider, 56, 58
- inventory, 12
- ISP, 58

K

- Kensington lock, 40, 88
- keyboard
 - embedded keypad, 33
 - ergonomic precautions, 19
 - euro symbol, 103
 - non US, 33
 - num lock, 33
 - opening, 89
 - status lights, 14, 18
 - troubleshooting, 102
- keypad (embedded), 33
- Keypad Lock, 14, 18

L

- LAN
 - connecting to, 63
 - troubleshooting, 103
 - wireless, 64
- LAN port
 - indicator lights, 63
 - location, 15
- laser safety, 147
- Library (HP), 13
- lights
 - LAN port, 63

- status, 14, 17, 18
- locking computer, 39
- LPT1 port, 15

M

- Main menu (BIOS), 119
- memory
 - adding, 89
 - extended, 119
 - PC2100 DDR-266, 89, 104
 - removing, 90
 - troubleshooting, 104
 - video, 119
- microphone
 - location, 14
- mini-PCI
 - location, 16
- modem
 - AT commands, 60, 138
 - black list, 58
 - blackout periods, 58
 - built-in, 22
 - connecting, 57
 - connecting to Internet, 58
 - dial-in connection, 59
 - faxing, 62
 - port location, 15
 - sending e-mail, 61
 - settings, 60
 - software, 56
 - troubleshooting, 104
- monitor
 - BIOS settings, 120
 - external, 82
 - port, 15
 - resolution, 82, 83
 - switching to, 33
- mouse
 - troubleshooting, 102
- movies (DVD), 38
- mute button
 - location, 15
 - using, 35

N

- network
 - connecting to, 63
 - dialing, 59
 - LAN, *See* LAN
 - wireless, *See* wireless network
- Norton AntiVirus, 41
- Notebook Web sites, 13
- NTFS format, 123
- Num Lock, 14, 18, 33

O

- off
 - button location, 14
 - status lights, 17
 - turning off, 26
- on
 - button location, 14
- One-Touch buttons
 - location, 14
 - using, 31
- Outlook Express, 61
- overheating, 101

P

- parallel device
 - connecting, 80
- parallel port
 - location, 15
 - troubleshooting, 112
- partition (Utility), 122
- password, 39
- PC Card slot
 - location, 15
- PC Cards
 - installing, 76
 - saving power, 53
 - stopping, 77
 - troubleshooting, 107
- PC2100 DDR-266 RAM, 89, 104
- PCMCIA cards, 76
- phone cord, connecting, 22
- plug requirements, 145
- pointing devices
 - configuring, 29
 - using, 29
- port locations, 15
- port replicator
 - connecting, 87
 - troubleshooting, 109
- power
 - connecting AC, 21
 - processor speed, 49
 - saving, 52
 - troubleshooting, 109
- power button
 - location, 14
 - resetting with, 27
- power cords, 145
- power management
 - automated, 48
 - schemes, 49
- PowerNow!, 49
- Powerplay, 53

- preparing
 - hard disk drive, 93
- Presentation Ready, 35
- presentations
 - preparing, 35
 - showing, 36
- printing
 - compatible printers, 80
 - infrared printers, 86
 - parallel connection, 80
 - troubleshooting, 111
- processor speed
 - managing, 49
- protection
 - files, 41
 - hard drive lock, 41
 - Kensington lock, 40, 88
 - Norton AntiVirus, 41
- PS/2 port
 - location, 14

Q

- Quick Lock, 39

R

- RAM
 - adding, 89
 - location, 16
 - PC2100 DDR-266, 89, 104
 - removing, 90
- rebooting
 - boot device, 121
 - temporary boot device, 27
- receiving faxes, 62
- recovering original software, 122
- Recovery CD or DVD
 - diagnostics, 117
 - replacing, 123
 - using, 122
- region code, 38
- registering computer, 24
- regulatory information, 149
- removing
 - CD, 37
 - DVD, 37
 - hard disk drive, 91
 - hard drive holder, 92
 - PC Card, 77
 - RAM, 90
- repair service
 - obtaining, 128
 - shipment, 129
- reset button, 27
- resetting, 27

- resolution
 - external monitor, 82
- S
- safety
 - battery use, 146
 - infrared port, 147
 - laser, 147
 - power cords, 145
 - wireless communication, 66, 68
- saving battery power, 52
- screen area
 - adjusting, 34
- scroll pad
 - location, 14
- secondary display, 83
- security
 - hard drive lock, 41
 - Kensington lock, 15, 40, 88
 - Norton AntiVirus, 41
- Security menu (BIOS), 120
- selecting items, 29
- sending faxes, 62
- serial connections
 - Bluetooth, 72
- serial port
 - connecting, 85
 - location, 15
 - troubleshooting, 112
- setting up, 19
- shut down, 50
- software
 - pre-installed, 12
- specifications
 - hardware, 134
- SpeedStep Technology, 49
- Standby mode
 - and display life, 45
 - definition, 26
 - status lights, 17
 - timeout, 26
- startup
 - troubleshooting, 113
- static electricity, 89, 90
- status lights
 - battery charge, 51
 - keyboard, 14, 18
 - location, 14
 - meanings, 17
- Support Ticket, 116
- suspending
 - and display life, 45
 - resuming and, 114
 - saving power, 53
 - troubleshooting, 114
- S-video port
 - location, 15
- system standby, 50
- T
- taskbar
 - HP Presentation Ready, 35
 - PC Card, 77
- technology code, 134
- temperature
 - limits, 136
 - overheating, 101
- timeouts
 - computer, 49
- touch pad
 - configuring, 29
 - location, 14
 - troubleshooting, 102
 - using, 29
- troubleshooting
 - audio, 96
 - battery, 109
 - display, 99
 - DVD drive, 97
 - hard disk drive, 100
 - HP Instant Support, 96
 - infrared communications, 101
 - keyboard, 102
 - LAN, 103
 - memory, 104
 - modem, 104
 - PC Card, 107
 - pointing devices, 102
 - port replicator, 109
 - power, 109
 - printing, 111
 - resuming, 114
 - serial, parallel, USB, 112
 - startup, 113
 - suspending, 114
 - wireless communication, 114
- turning on computer, 23
- TV Now, 84
- typing
 - special characters, 33
- U
- URLs, 13
- USB
 - connecting devices, 80
 - troubleshooting, 112
- USB ports
 - location, 15
- Utility partition
 - creating, 122
- V
- ventilation, 44, 101
- video memory, 119
- virus protection, 41
- voltage requirements, 145
- volume
 - adjusting, 30, 35
 - troubleshooting, 96
- volume control
 - location, 15
- W
- warranty
 - repair, 128
- Web sites, 13
- Windows
 - documentation, 13
 - key, 32
 - password, 39
 - reinstalling, 122
 - setting up, 23
 - updating drivers, 124
- wireless communication
 - Bluetooth, 68
 - configuring (Bluetooth), 70
 - indicator light, 14, 66, 68
 - infrared, 85
 - on-off button, 64
 - restrictions on use, 66, 68
 - status, 67
 - troubleshooting, 114
 - turning off (Bluetooth), 69
 - turning on, 66
 - turning on (Bluetooth), 68
- wireless network
 - AdHoc, 65
 - connecting to, 64
- Z
- Zip drive, 80